

	E.E.PLI.	SEE.PLI.A	SEE.PL.2.	C.E. PL.4.	SEE. PL.7.	SWE. PL.16.	J.L.EVE. 100-114(16)	SCOTTISH A.C.
D.2°	51102	51104	51100	51103	51105	51101	51107	51106
DD.2°				51108	51109	51110		51111
D.10°				51114	51113	51112	51115	
DD.10°				51116	51117	51118		
D.30°	51119	51120		51121	51122	51123	51115	
DD.30°				51124	51125	51126		
D.56°		51127						
D.60°	51128	51129		51130	51131	51132	51133	
DD.60°				51134	51135	51136		
D.90°		51137		51138		51139	51140	
DD.90°				51141		51142		
D.T.	51143	51144	51146		51148	51149	51151	51152
DT.90°	51143	51145					51151	51153
DT.45°		51144						
DDT.					51148	51150		
DDT.90°				51147	51148			
DDT.60°								

51152
51153 B.KNOX.

51154 B.KNOX.

	E.E. PLI.	C.E. PLI.	SEE.PLI.A	SEE. PL.2.	C.E. PL.3.	SCOTTISH	SPECIAL.
S.2°	51155	51156	51157	51158	51159	51172	
S.10°				51160		51173	
S.30°	51161		51162	51163		51174	
S.60°	51164	51165	51166	51167		51175	51176
S.T.	51168		51169			51177	
S.T.45°			51170				
S.T.90°			51171				

	275/380KV TWIN O-4" L2. 1956.	275KV TWIN O-175" L3. 1956.
D.	51179	51186
D.10°	51180	51187
D.30°	51181	51188
D.60°	51182	51189
D.T.	51183	51190
S.T.	51184	51191
S.T.X.	51184	
D.J.X.	51185	
D.15° E.W.C.O.	51181	
D.40° E.W.C.O.	51192	

35/4086 SFX 275/380KV -4° L2 1956
S60° ROTATED BASE 132KV -175° D°

✓ S.C. GANTRY 132KV -4° J.L.EVE

✓ DX PIRELLI 132KV. PL. IA

✓ SCT GANTRY 132KV. -175° B.LAW KNOX

✓ D90° JUNCTION TOWER 132KV -175° B

✓ DX PIRELLI SPECIAL 132KV. PL. IA

✓ D60° JUNCTION TOWER 132KV -175° B.

31/1308 D/LEAD GANTRY 132KV. -175° B.KNOX

✓ GC GANTRY GOAL POST 132KV -4° J.L.EVE

35/4840 ST GANTRY 132KV. -175° W.P. 1958 B. KNOX

CROSSING TWR. (USED AT COLNE)
132KV TAMAR & TAVY

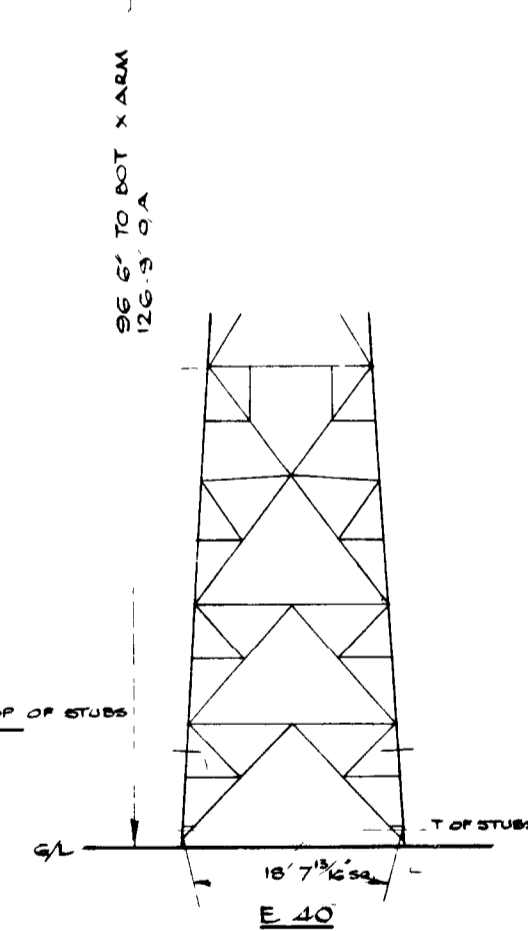
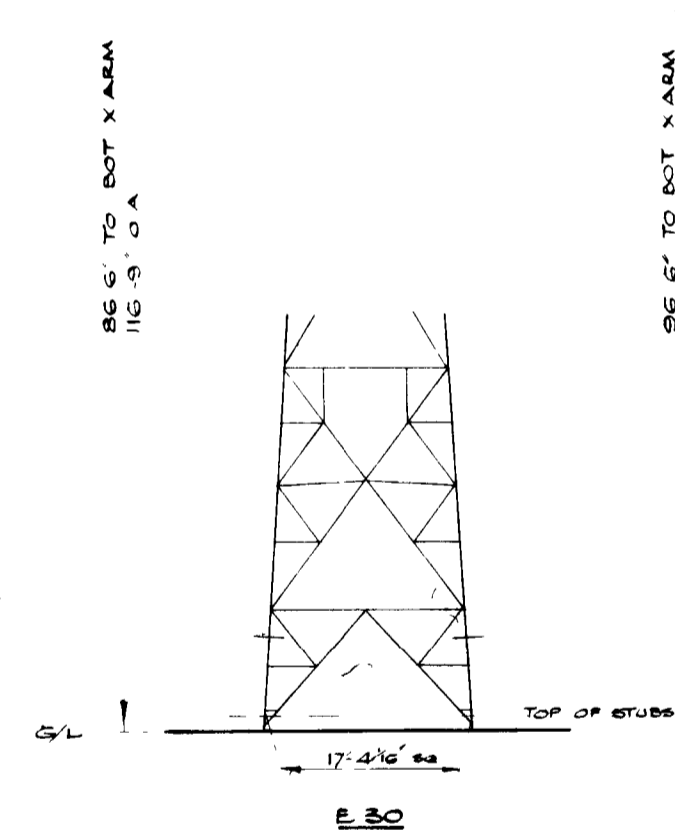
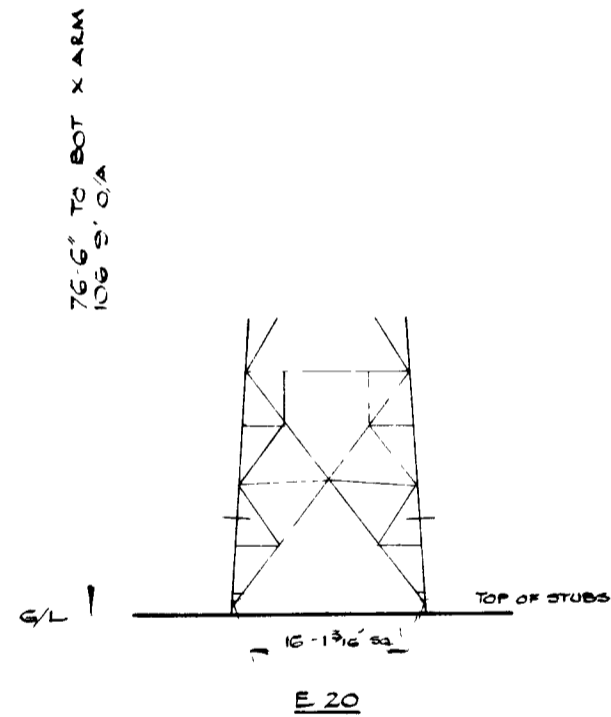
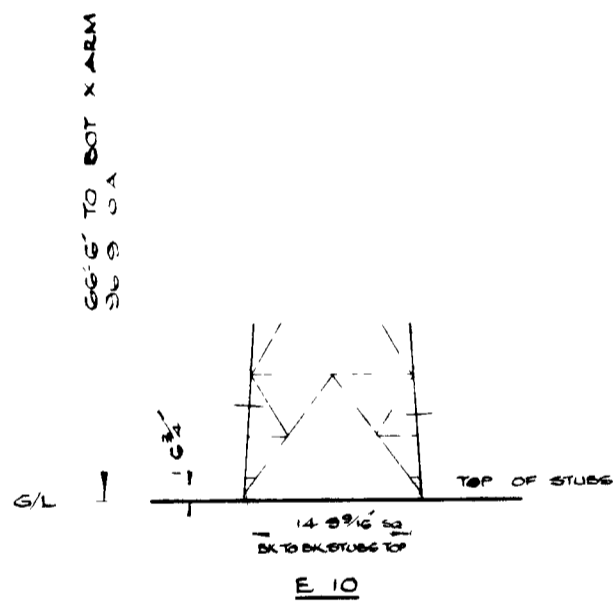
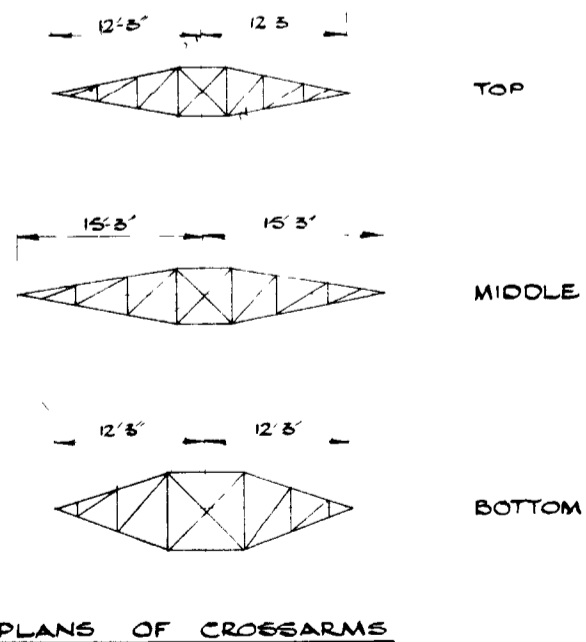
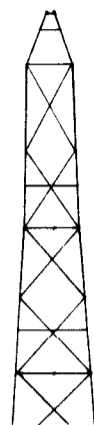
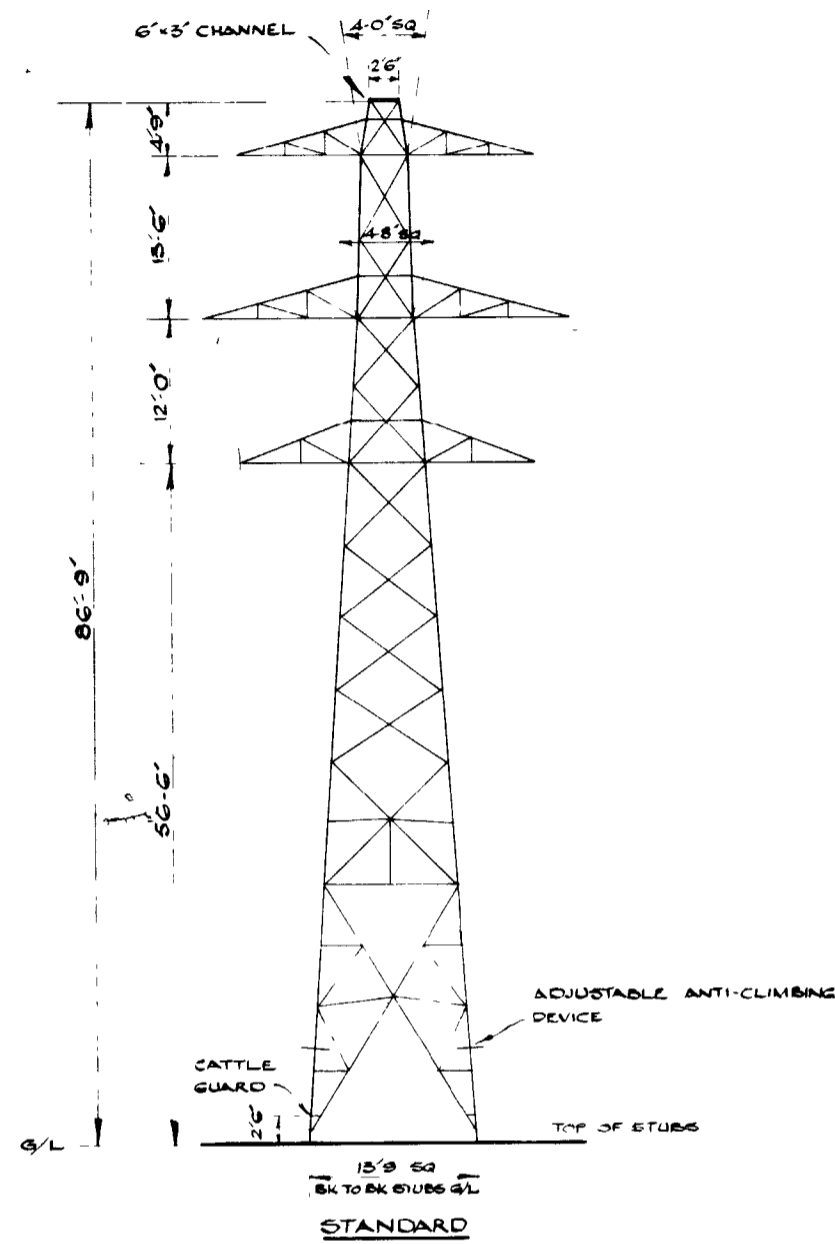

REF DRGS	GEN ARRGT	ERECTION
D.2° STANDARD	35/800	35/921
E.10 E.20 E.30	35/394	35/913
E.40	35/3535	

DROPPER LENGTH 11"

D.2° TOWER. (BLAW KNOX)
DESIGN TYPE: SWE. PL.16.

SCALE:- 1/16" TO 1 FT

DRAWN	LWF	5 8 56
TRACED		
CHECKED		

A

DRG. NO. ED.51101

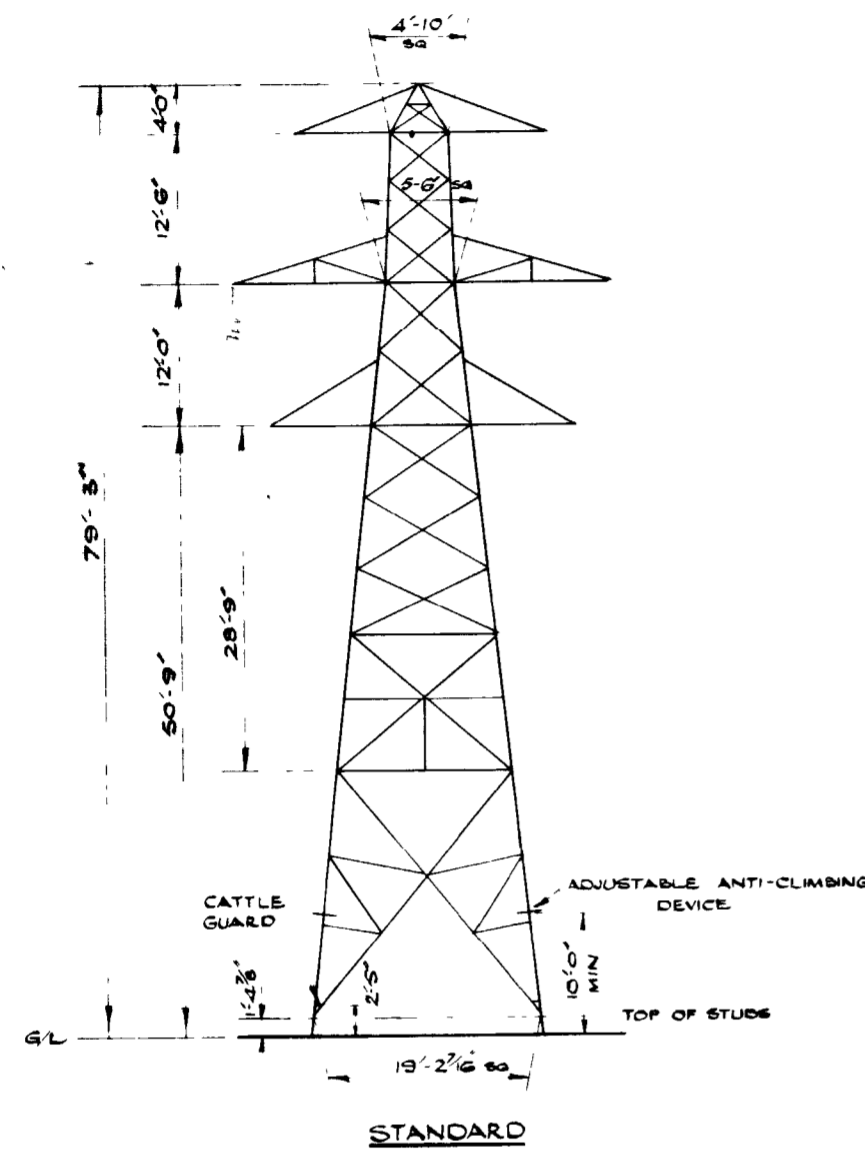

STANDARD

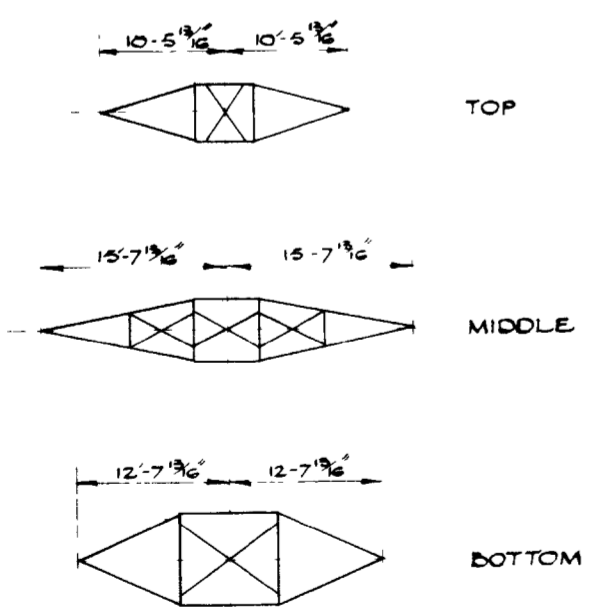

INVERTED PLANS OF CROSSARMS

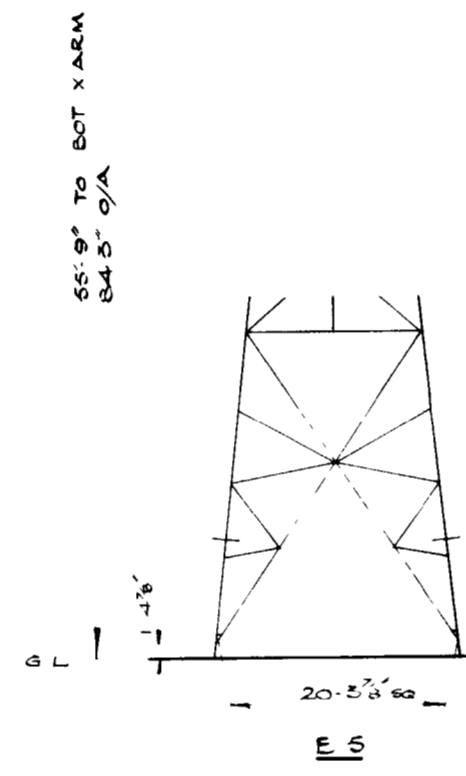
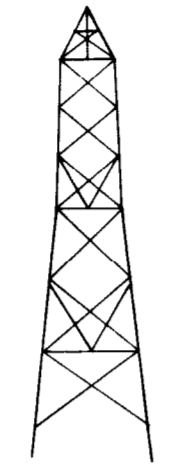

E 5

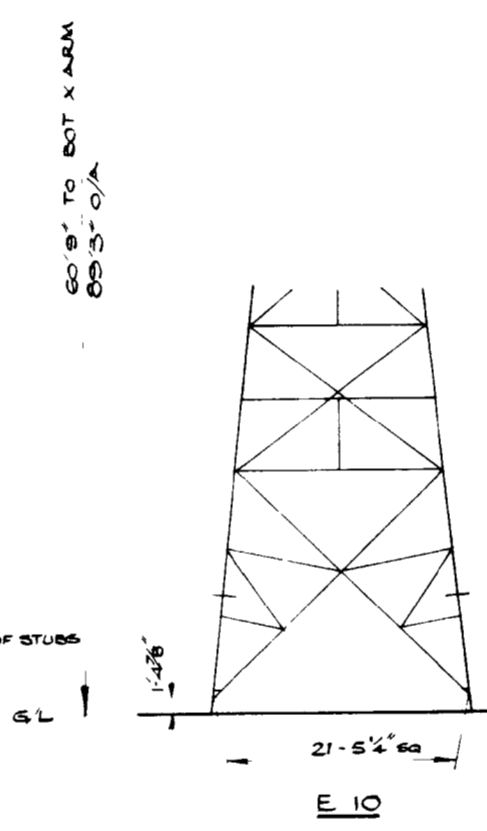

E 10

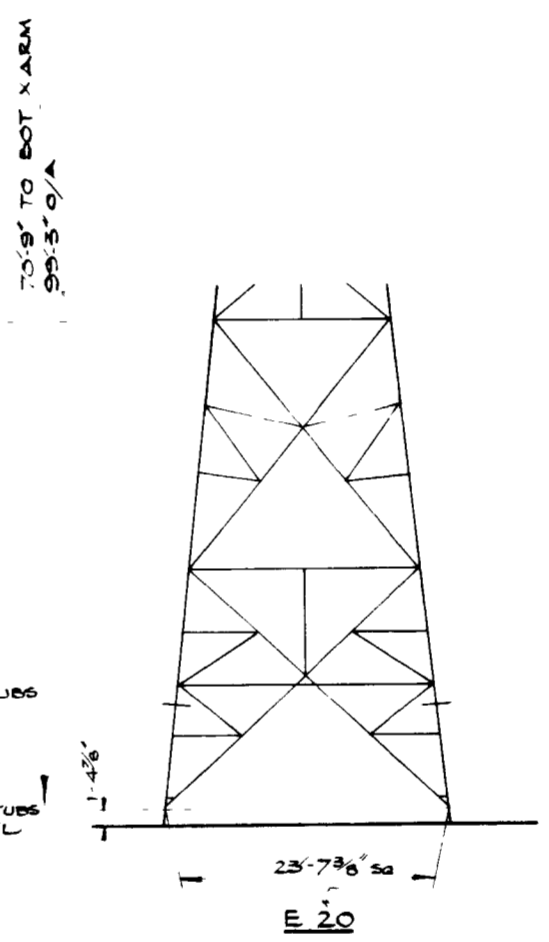

E 20

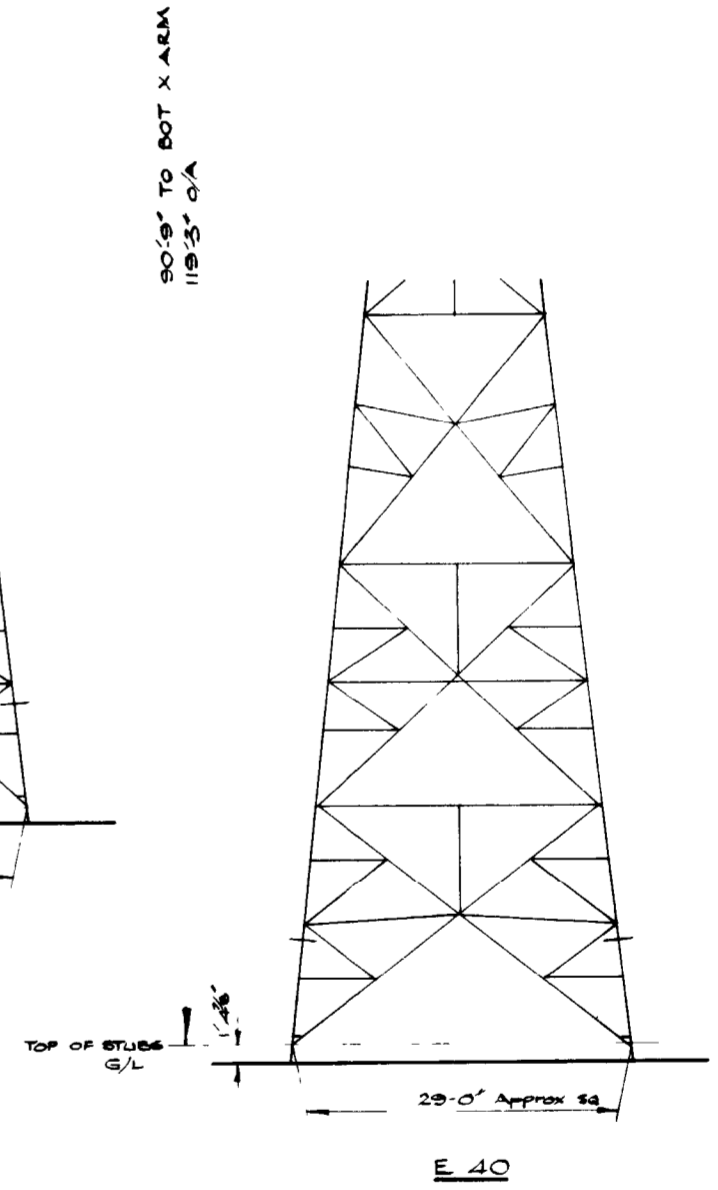

E 40

REF DRGS

REF DRGS	GEN ARRG	ERECTION
D2 D2 E5 D2 E10	35/1941	35/5729
E 20	35/1942	35/5730
E 40	35/1943	

DROPPER LENGTH 1'-0"

D. 2° TOWER. (MILLIKEN)
 DESIGN TYPE: EE. P.L.I.

SCALE: 1/16" TO 1 FT

DRAWN	LWF	5-8-56
TRACED		
CHECKED		

A

DRG. NO. ED. 51102

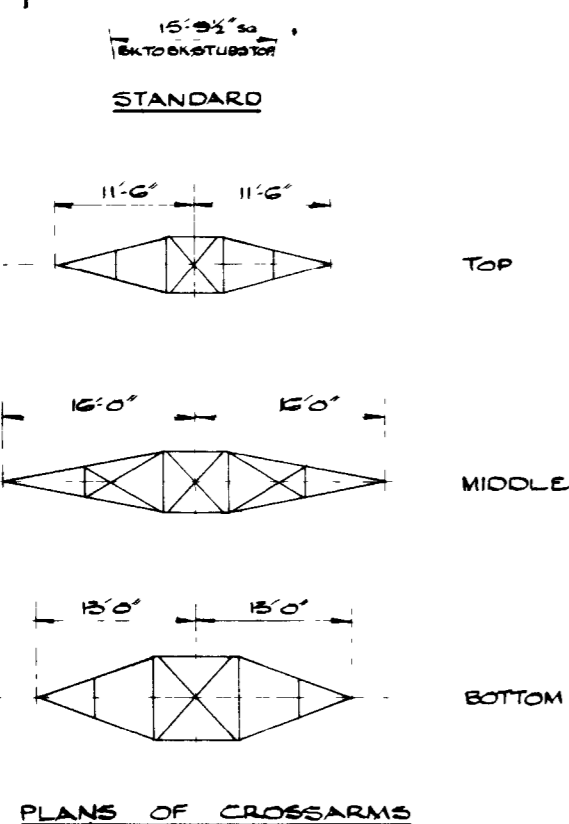
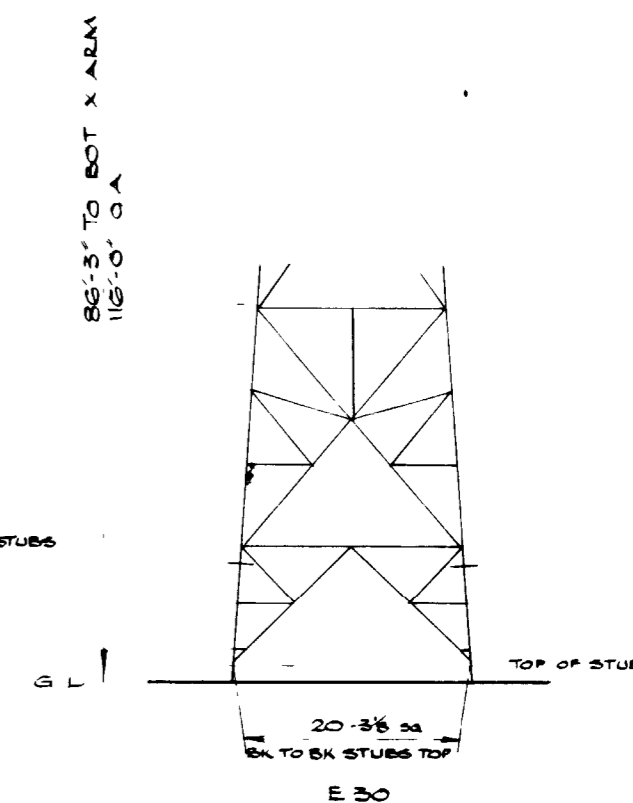
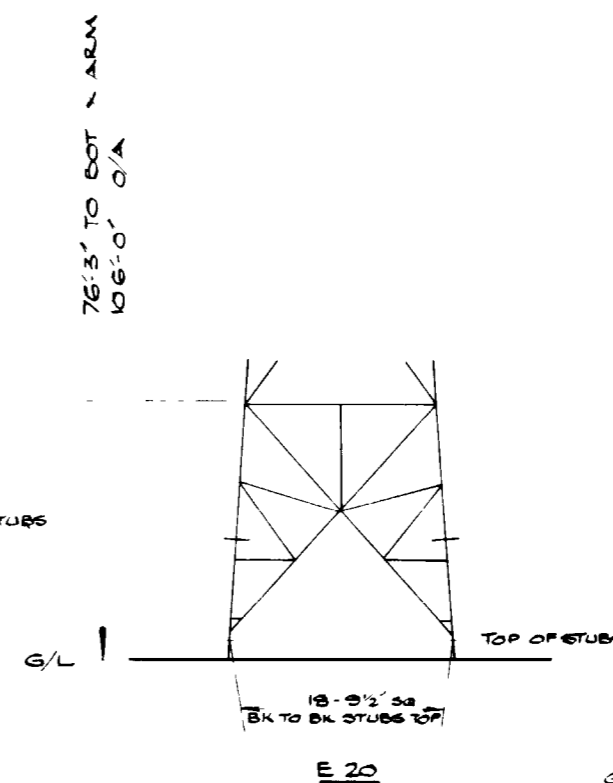
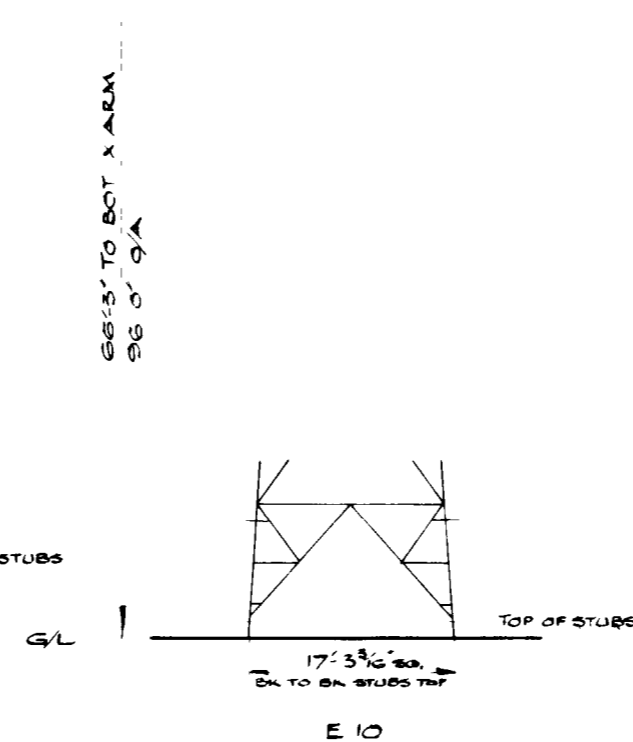
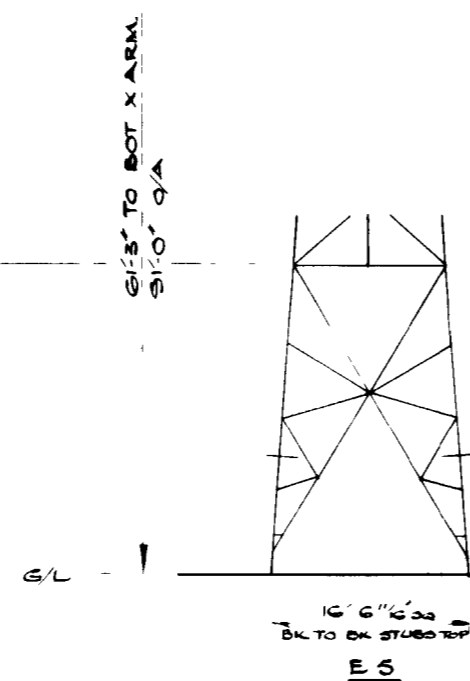
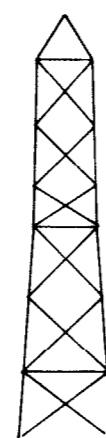
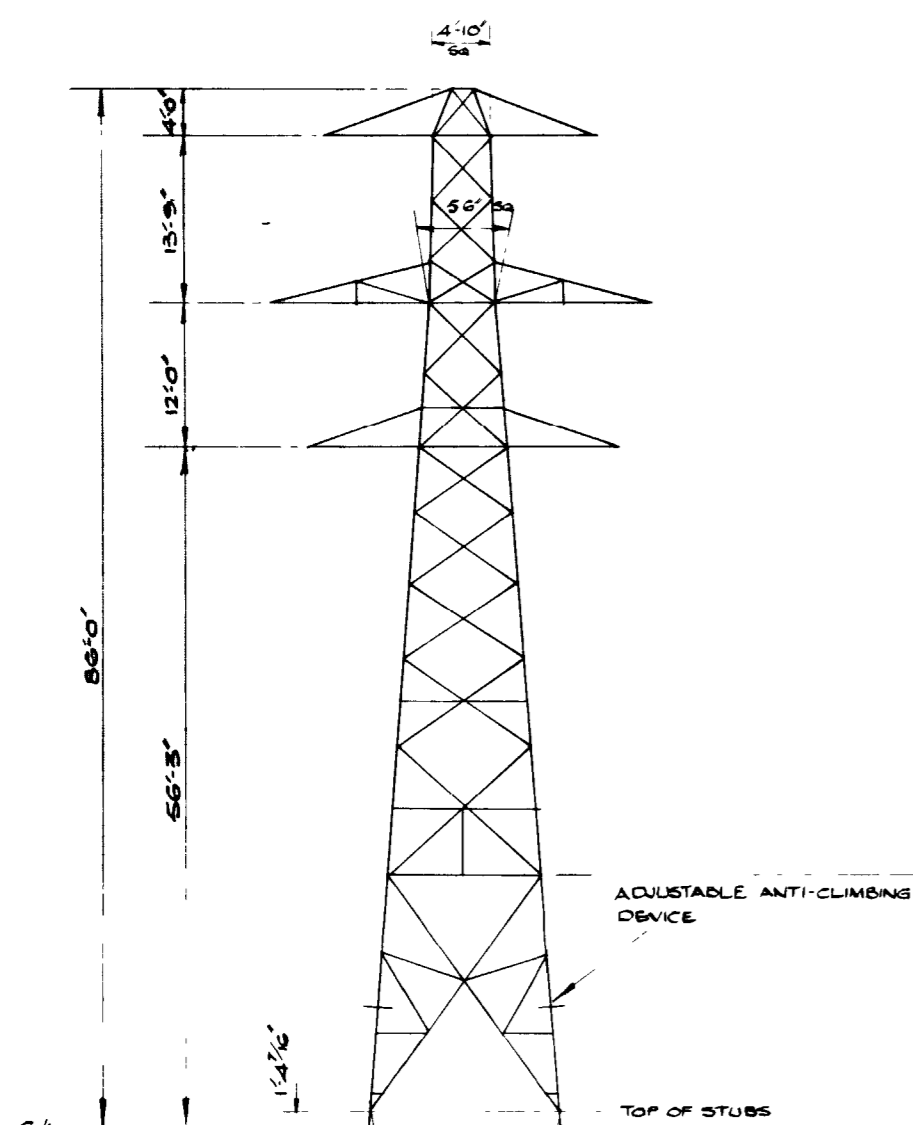

REF DRGS	GEN ARRGT		ERECTION
D 2° GEN ARRGT	35/1680	35/810 35/790	35/820
E 5 & E 10	35/821	35/822	35/822
E 20 & E 30	35/824		

DROPPER LENGTH - 3' APPROX

D 2° TOWER. (BLAW KNOX)
 DESIGN TYPE: C.E. PL.4.

SCALE:- 1/16" TO 1 FT

DRAWN	LWF	14 8 66
TRACED		
CHECKED		

A

DRG. NO: ED.51103

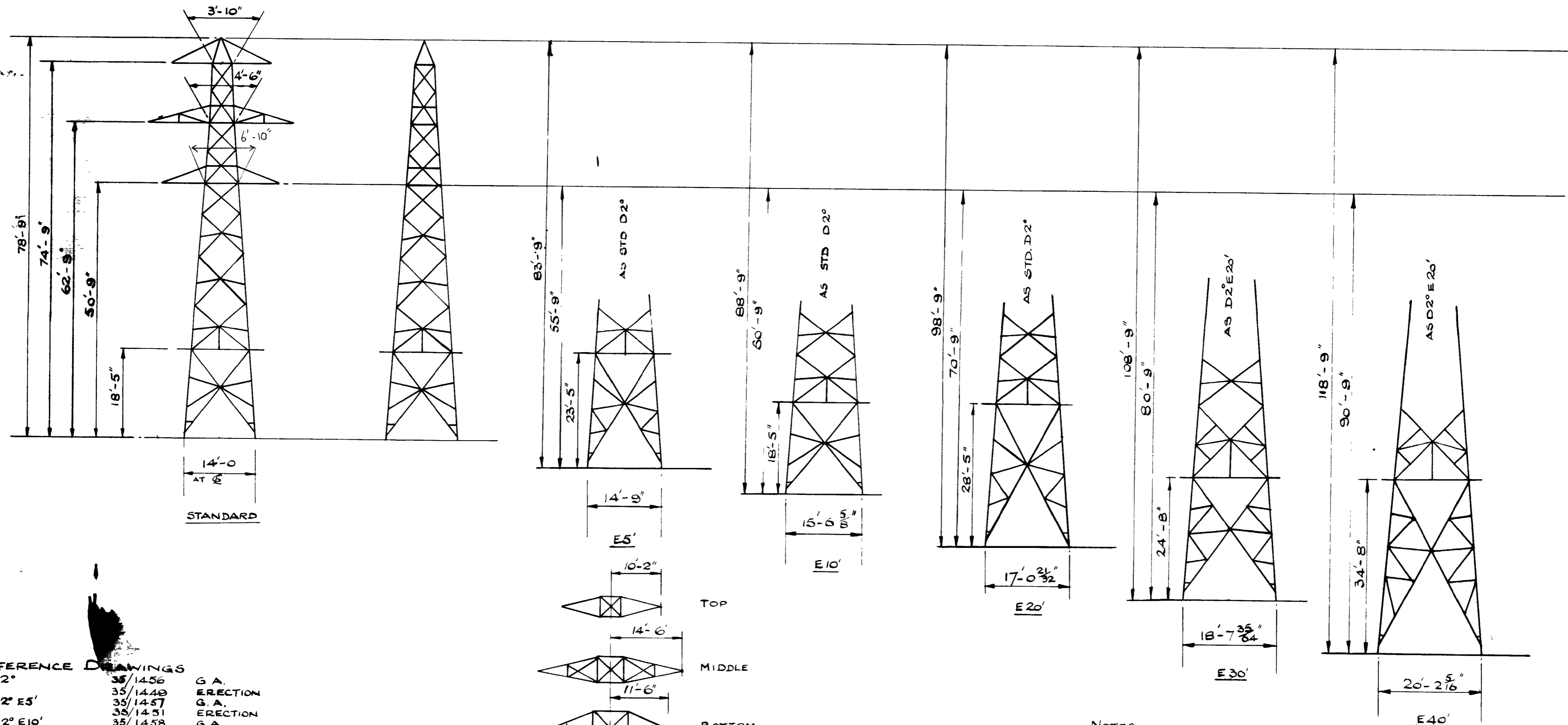

REFERENCE DRAWINGS

D2°	35/1456	G.A.
D2° E5'	35/1449	ERECTION
D2° E10'	35/1451	G.A.
D2° E20'	35/1458	ERECTION
D2° E30'	35/1448	G.A.
D2° E40'	35/1459	ERECTION
	35/1495	G.A.
	35/1516	G.A.

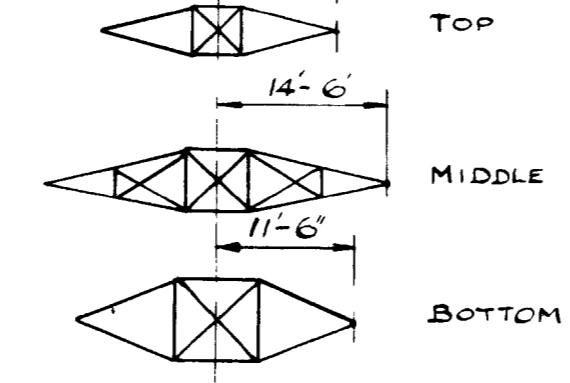

INVERTED PLANS OF CROSSARMS

NOTES

DROPPER LENGTH FROM UNDERSIDE OF CROSSARM 1-3 1/8"

SHT 1 OF 2 SHEETS

D2° TOWER (PIRELLI)
DESIGN TYPE PL (a) & EXT.

SCALE: 1/16" = 1'

DRG. No. ED51104

DRAWN	KAK	13-0-56
CHECKED		

A

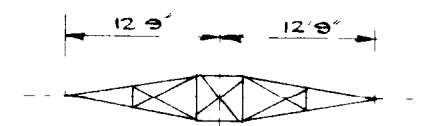
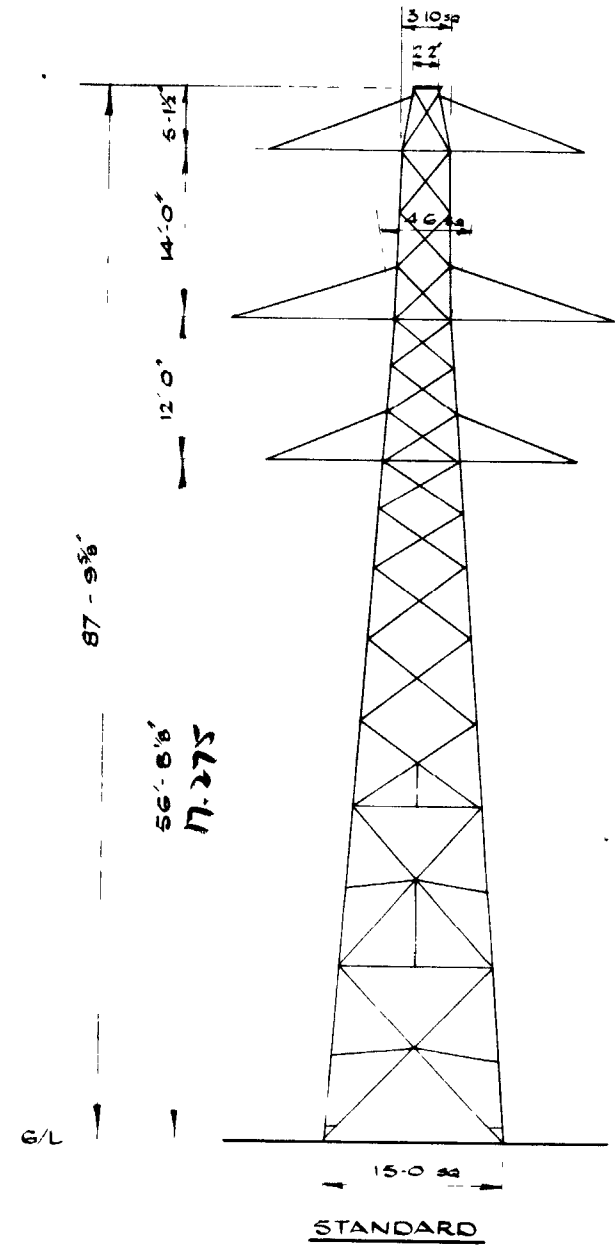

TOP

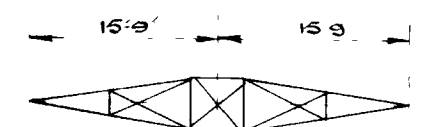

MIDDLE

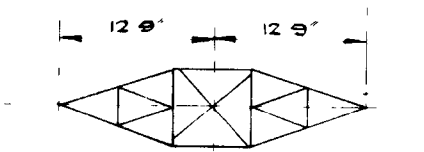

BOTTOM

PLANS OF CROSSARMS

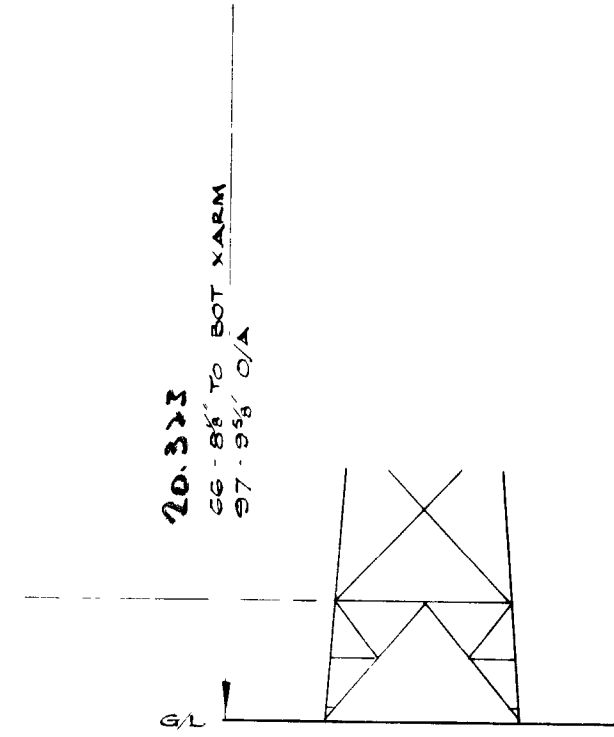
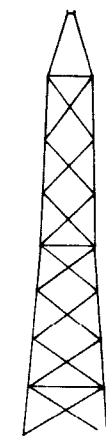

E 10

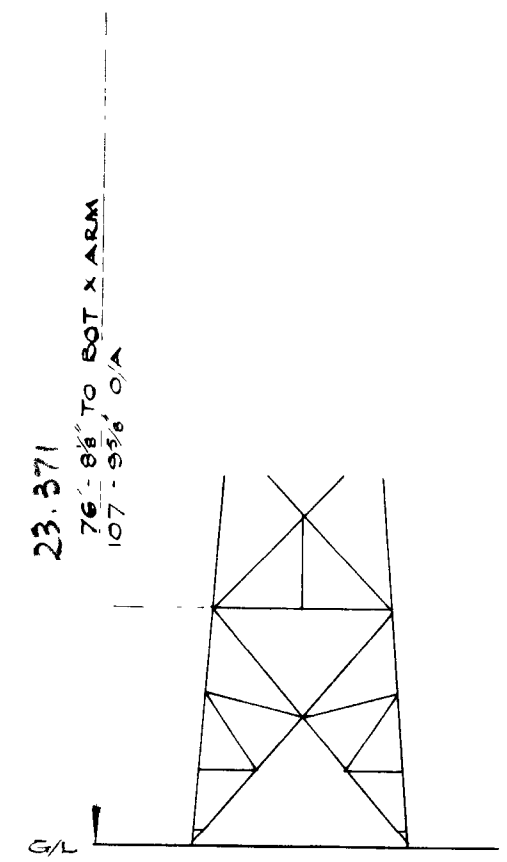

E 20

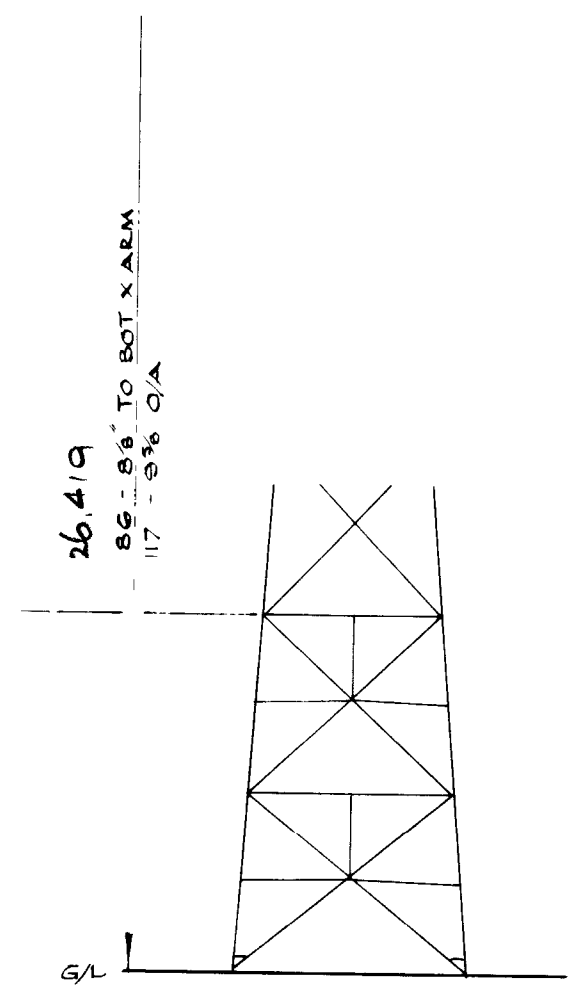

E 30

REF DRGS

GEN ARRET	STANDARD	35/1652
"	10' 0" EXT	35/1653
"	20' 0" & 30' 0" EXT	35/1654
"	40' 0" EXT	35/1655

DROPPER LENGTH 1'-0"

D.2° TOWER. (WATSHAMS)
DESIGN TYPE: S.E.E. P.L.7

SCALE: 1/16" TO 1'-0"

DRAWN	LWF	20.8.56
TRACED		
CHECKED		

A

DRG. NO: ED.51105

49.25.

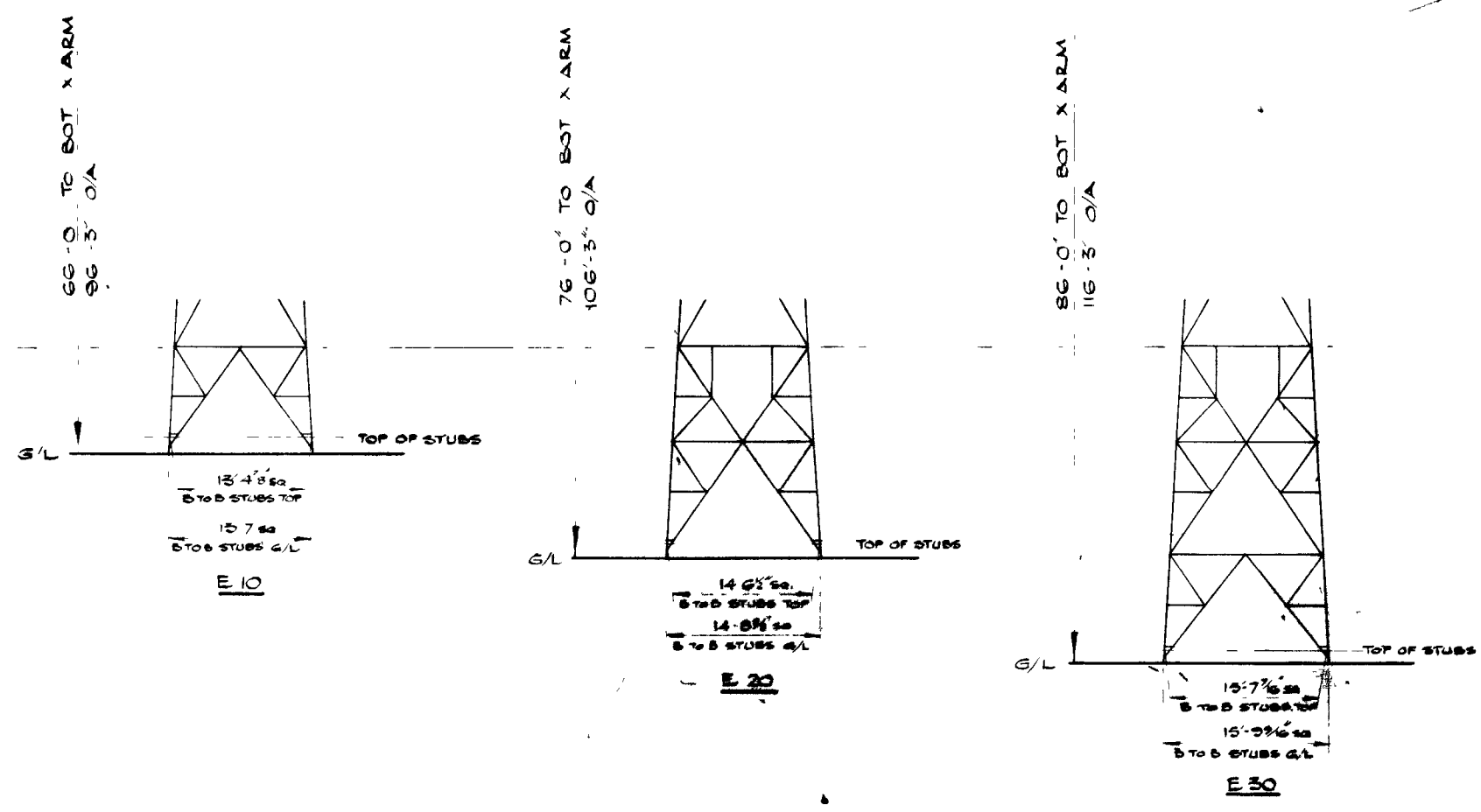
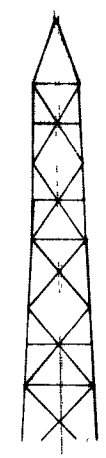
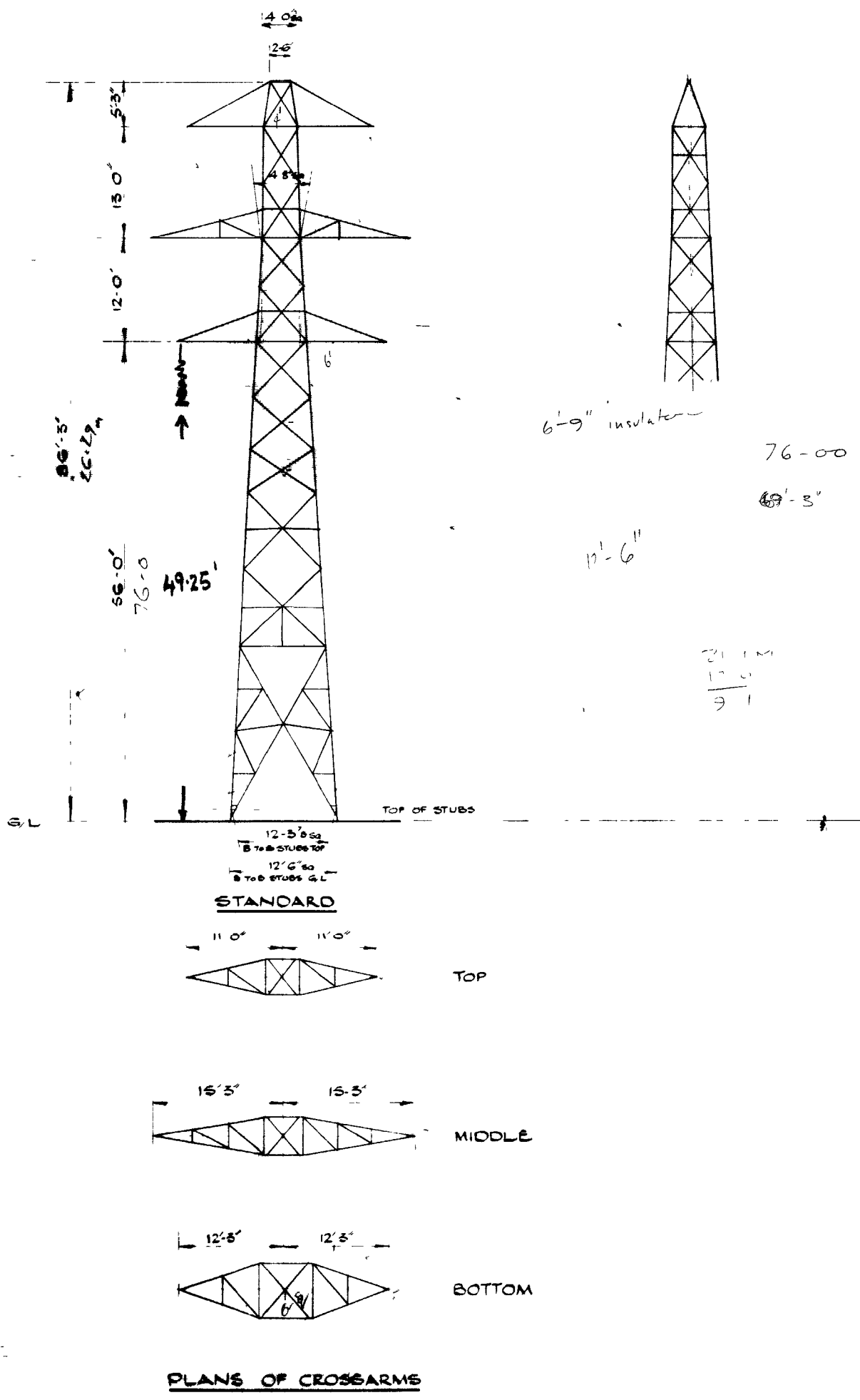

4140
2070

49 3
6 7

REF DWGS
 STANDARD & EXTENSIONS
 GEN. ARR. 55/548
 ERECTION 35/508

K1126
 D. 2' TOWER. (BLAW KNOX)
 DESIGN TYPE: SCOTTISH.
 SCALE: 1/16" = 1 FT

DRAWN	LWF	15 5 36
TRACED		
CHECKED		

A

DRG. NO. ED.51106

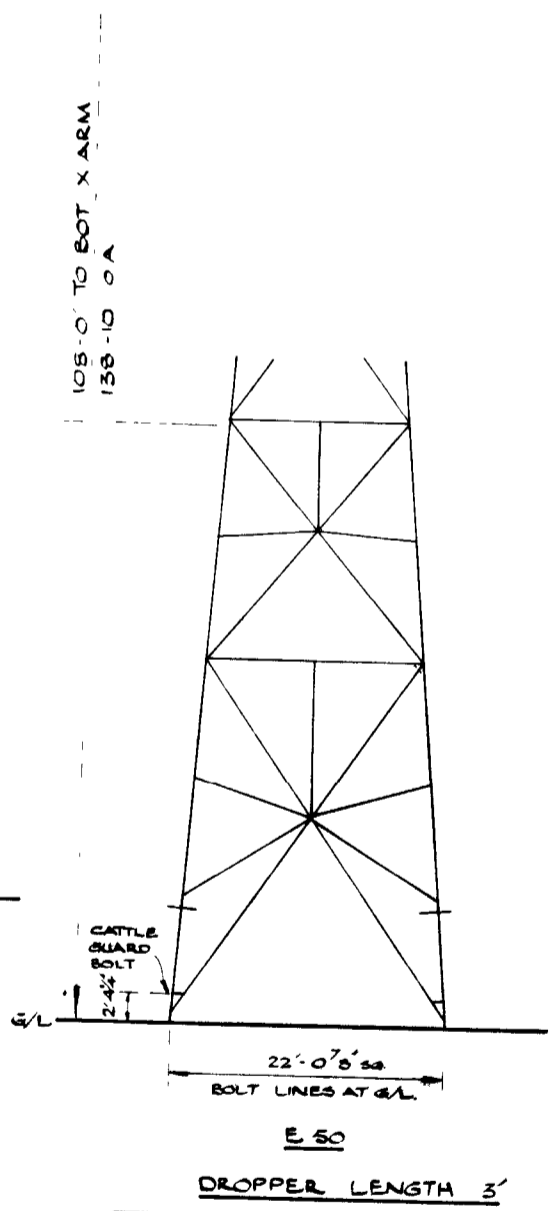
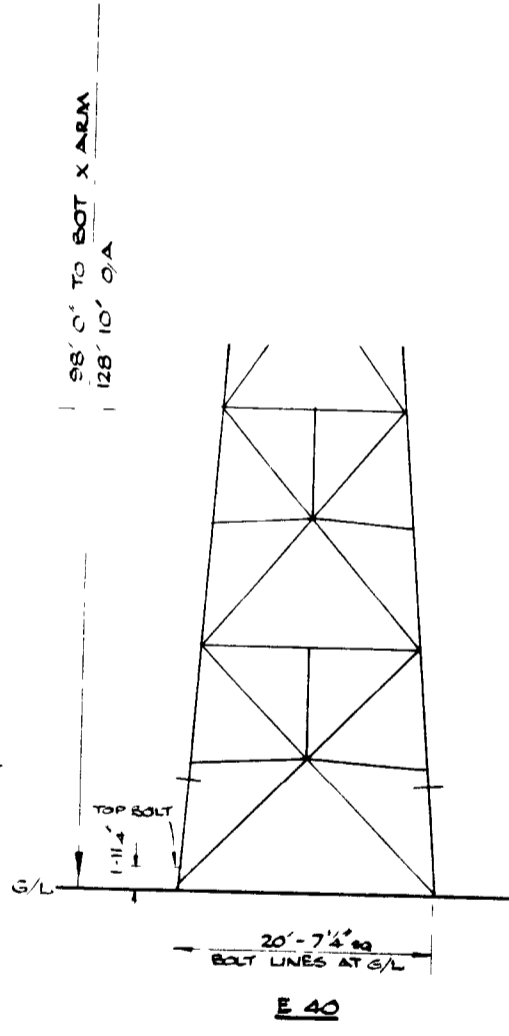
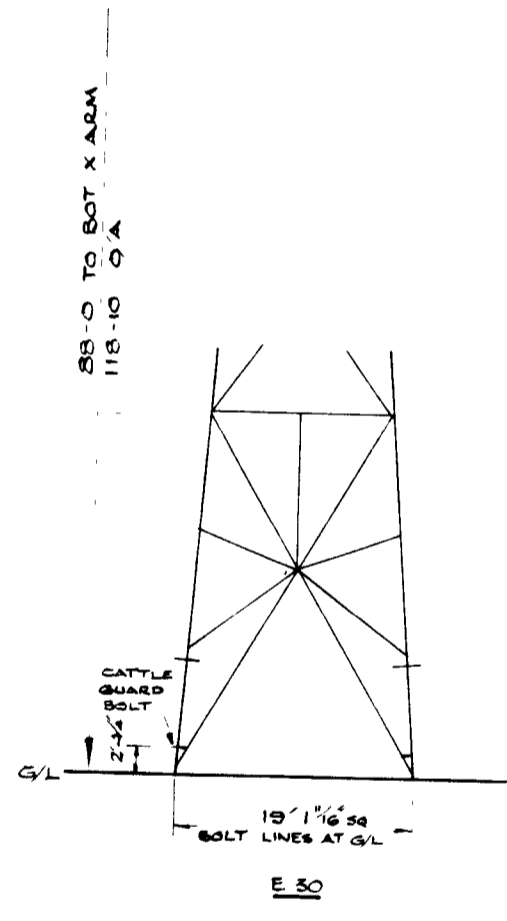
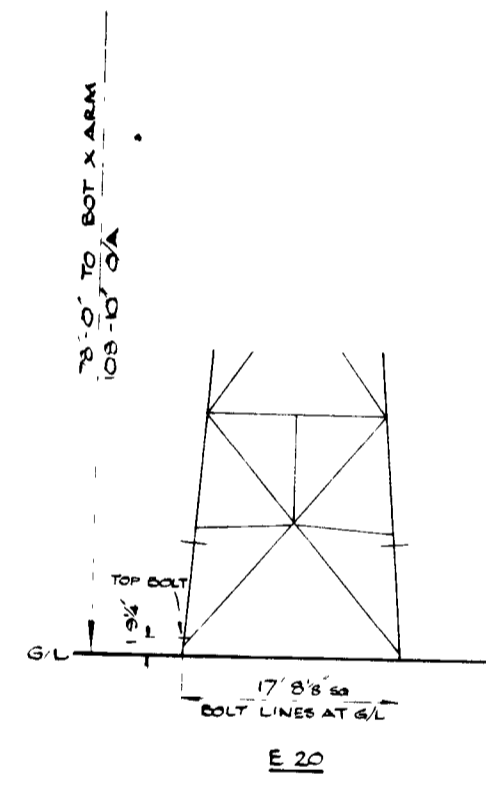
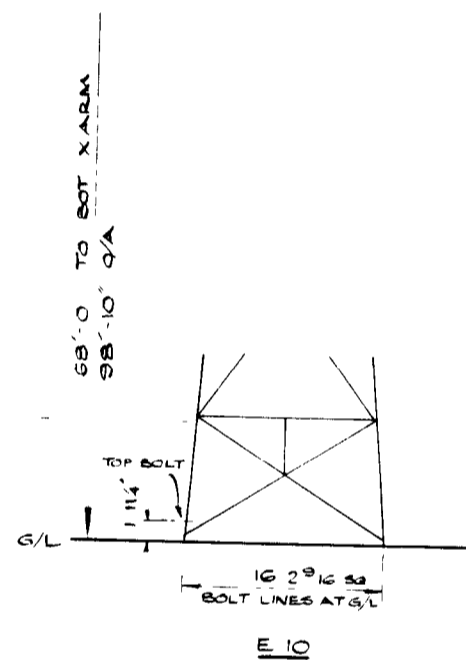
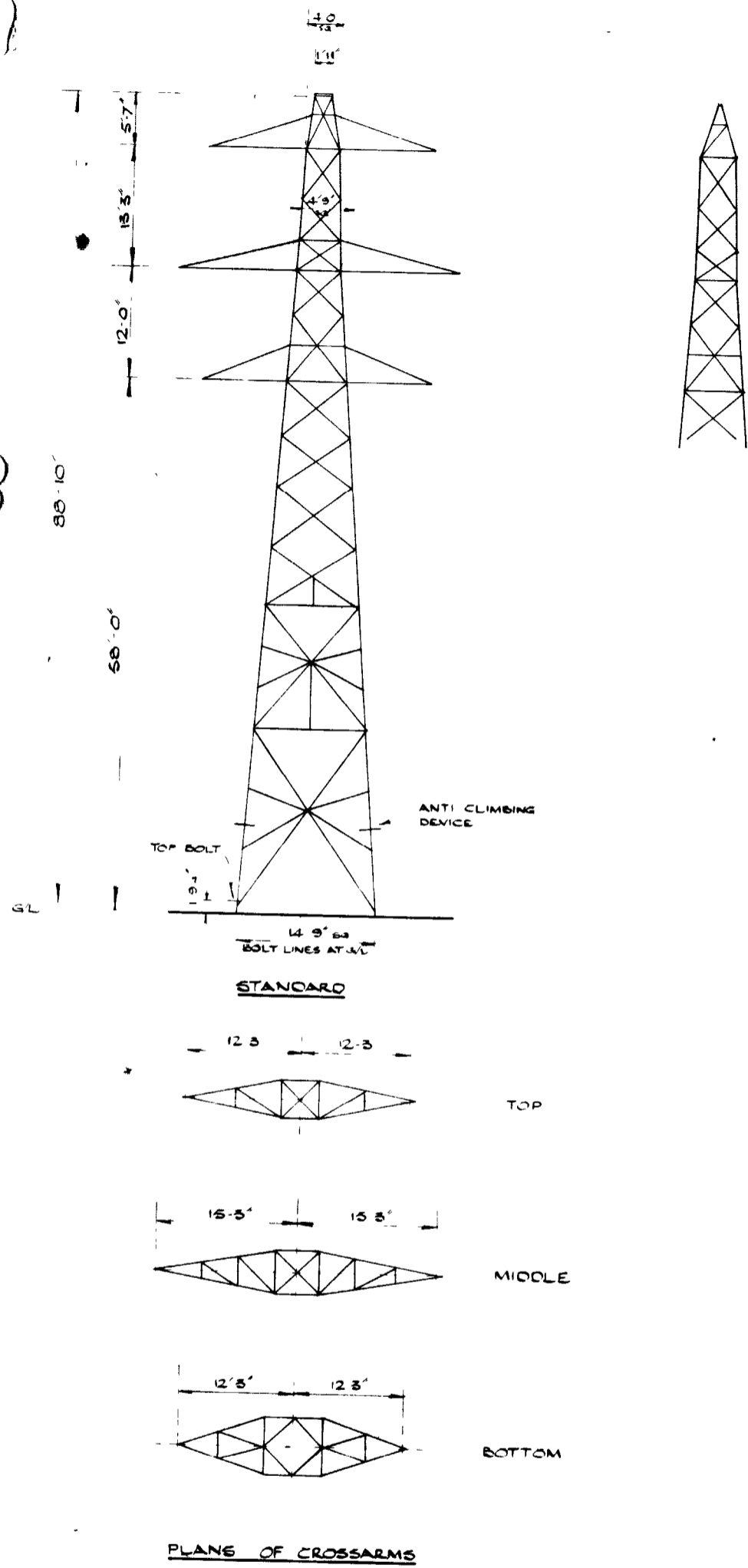

REF DRGS

SEN ARGT	STANDARD	35/3515
	10' 20' 30' EXT	35/3520
	40' EXT	35/3519
	50' EXT	35/3479

DRAWN	LWF	21 2 50
TRACED		
CHECKED		

D. 2° TOWER.
 DESIGN TYPE: J.L. EVE.
 SCALE: 1/8" TO 1 FT

DRG. NO.	ED. 51107.
----------	------------

A

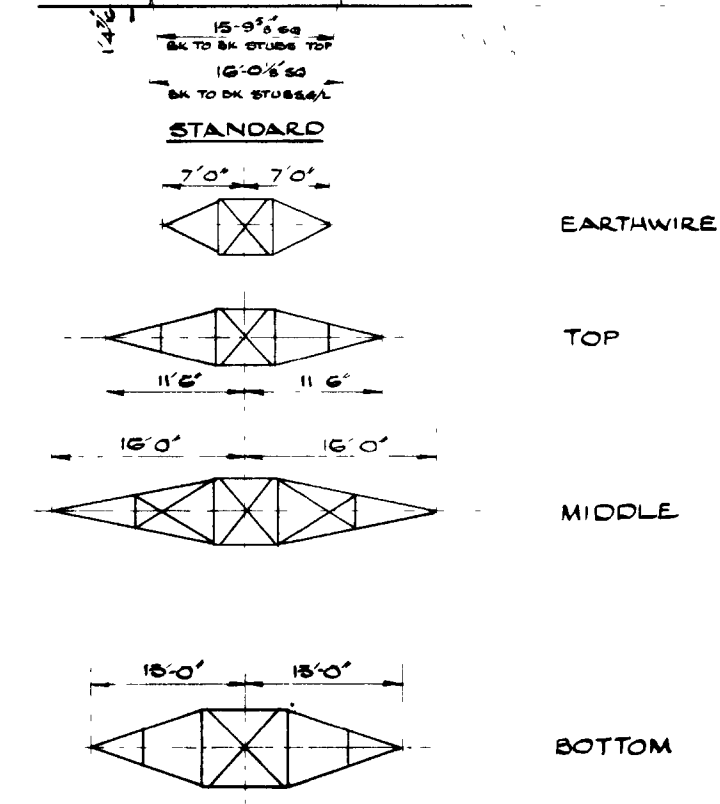
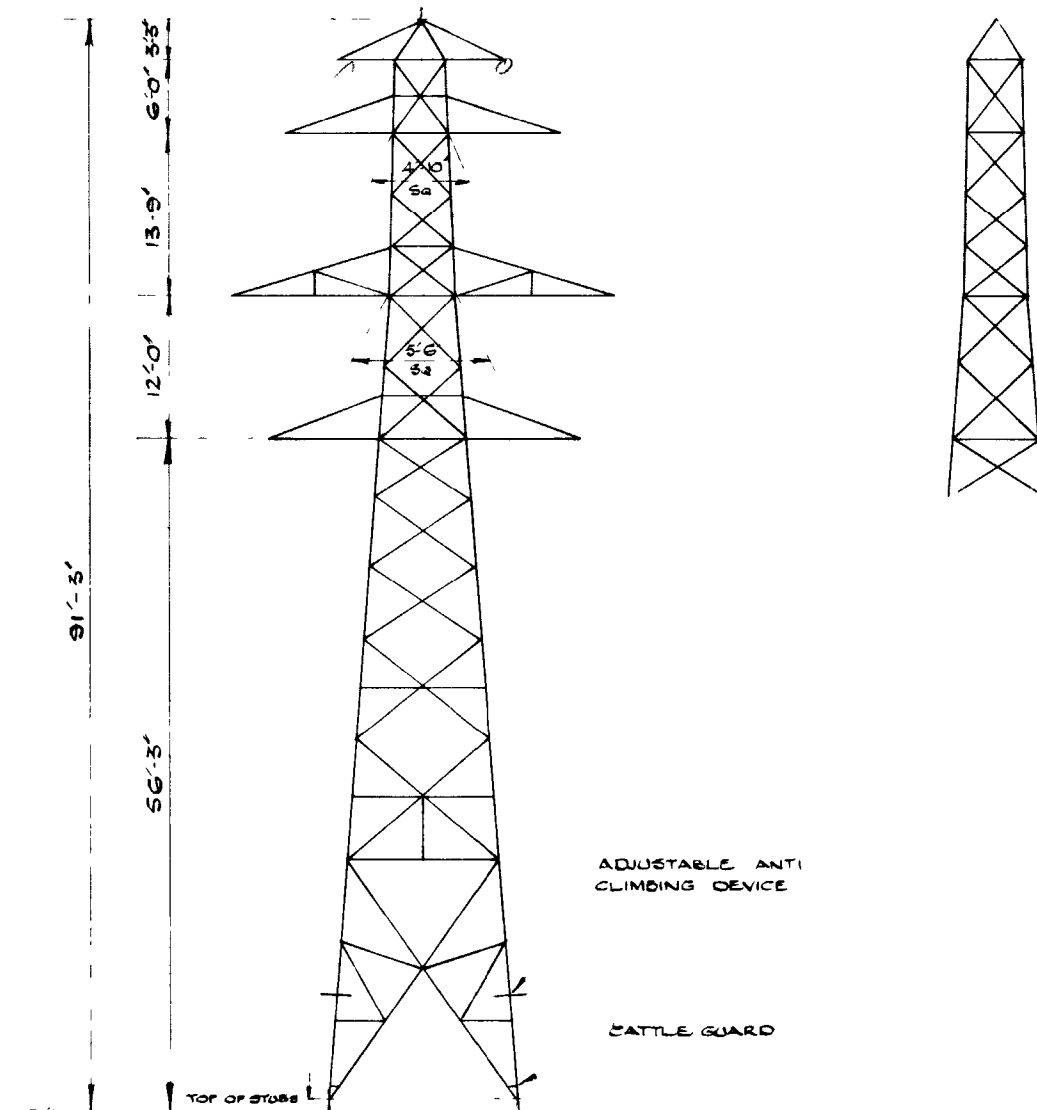

PLANS OF CROSSARMS

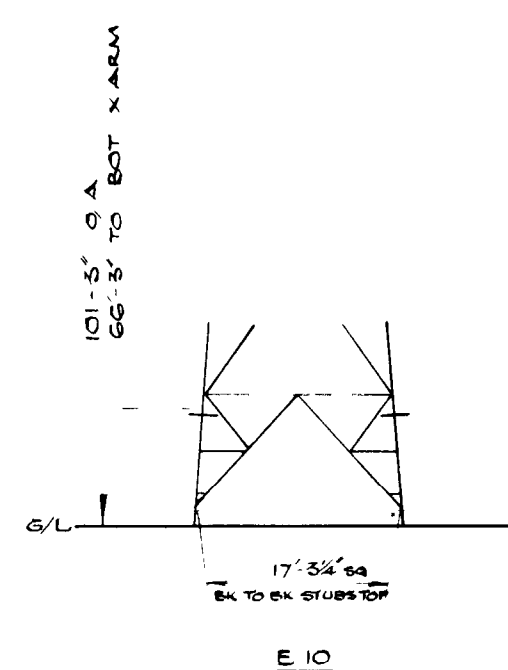

E 10

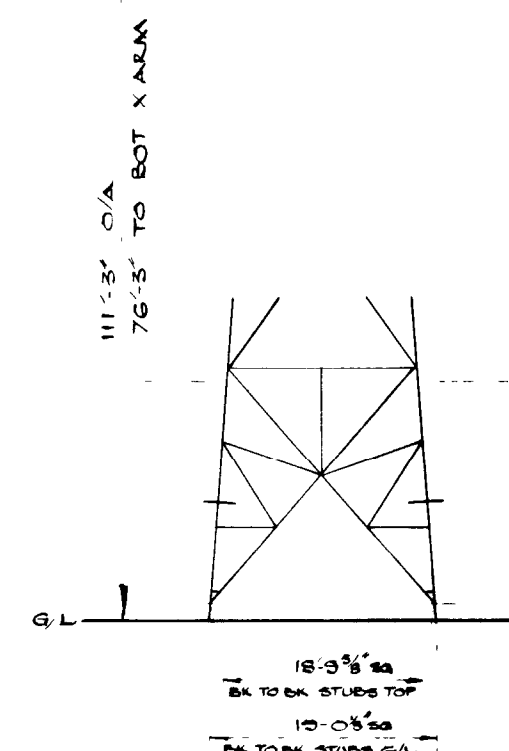

E 20

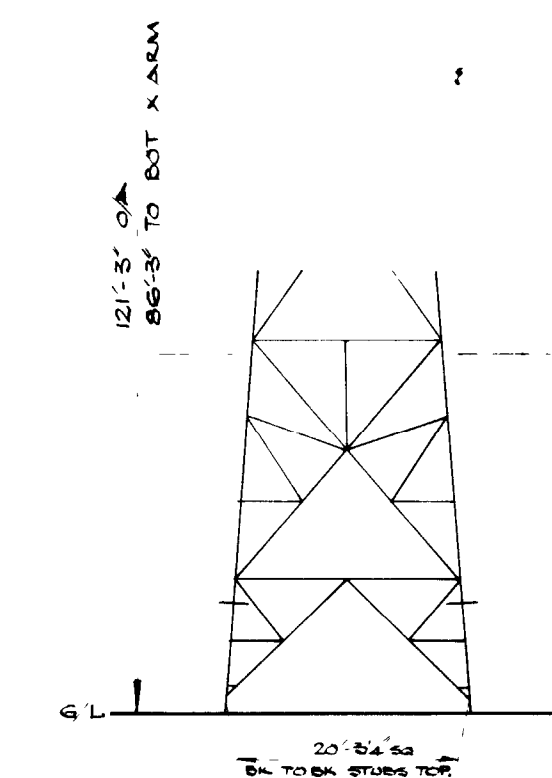

E 30

REF DWGS

STANDARD
10' EXT
20' EXT
30' EXT

GEN ARRGT

35/792
35/849

ERECTION

35/846
35/848
35/852
35/852
35/850

DROPPER LENGTH 3'

D.D. 2° TOWER. (BLAW KNOX)
DESIGN TYPE. C.E.P.L.4.

SCALE: 1/4" = 1 FT

DRAWN	LWF	24-3-52
TRACED		
CHECKED		

A

DRG. NO. ED.51108.

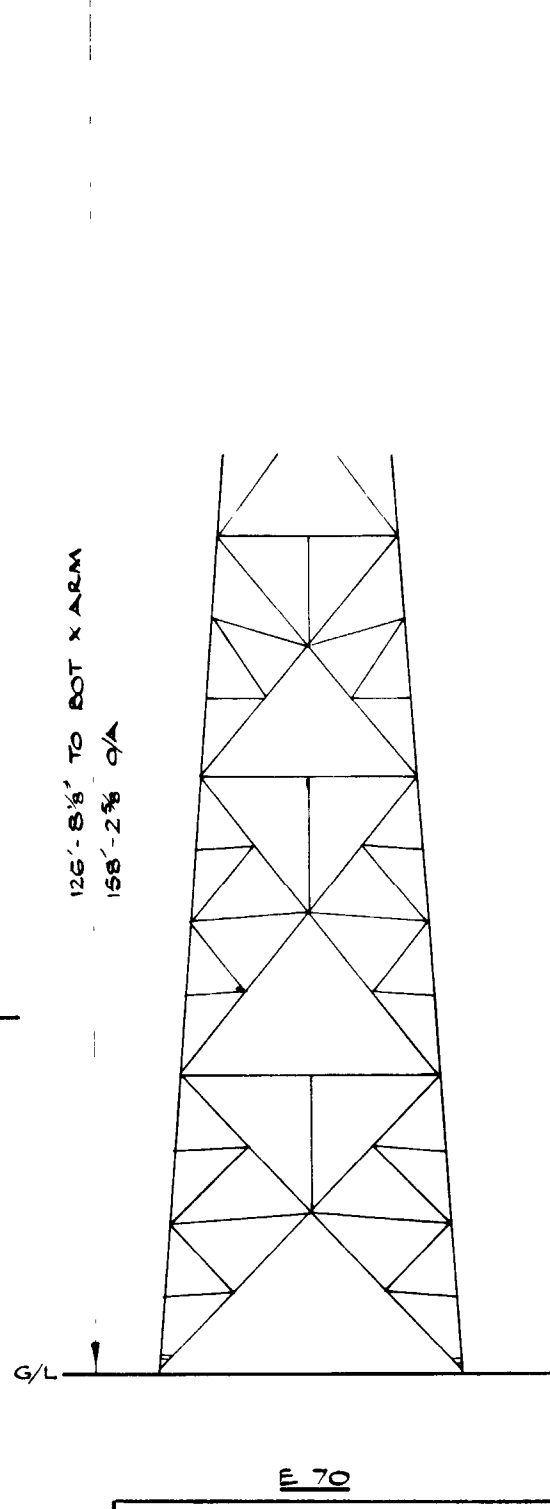
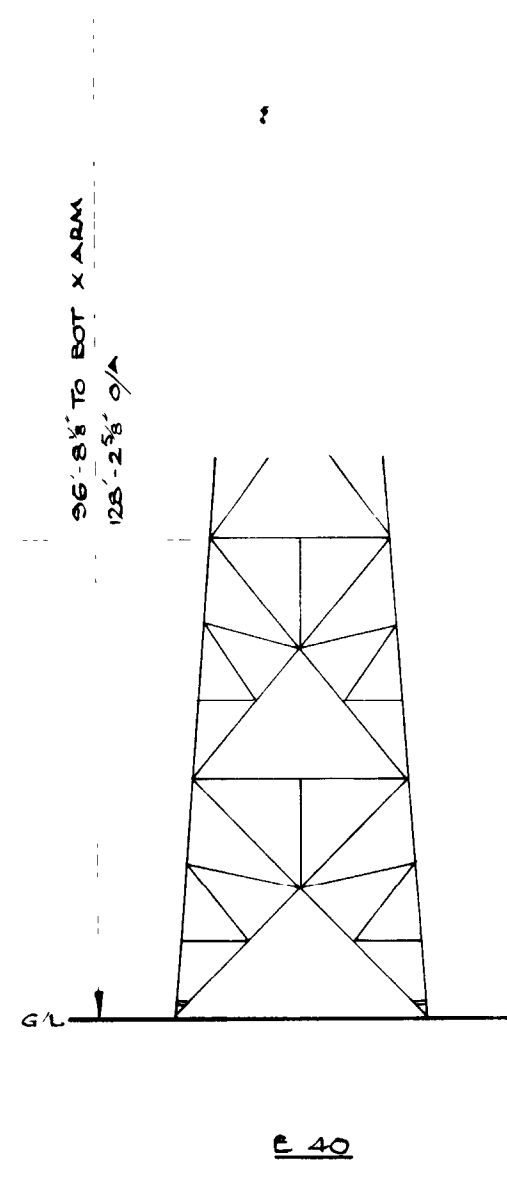
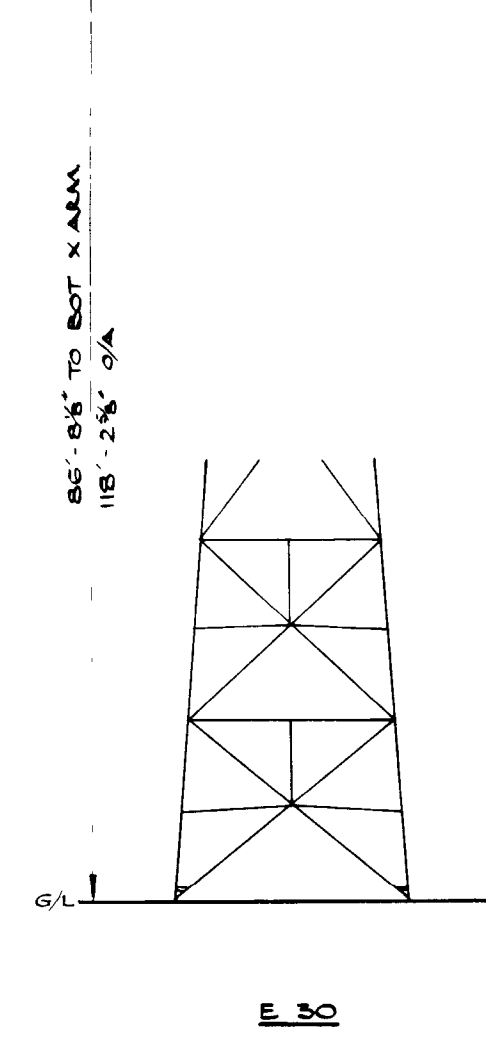
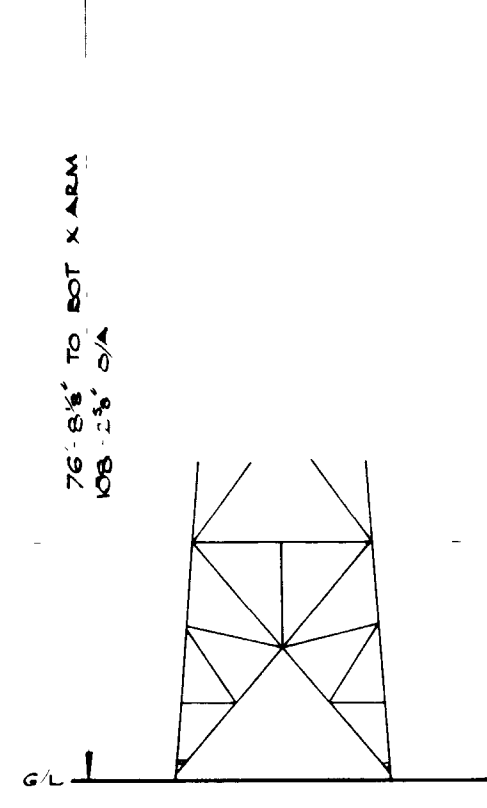
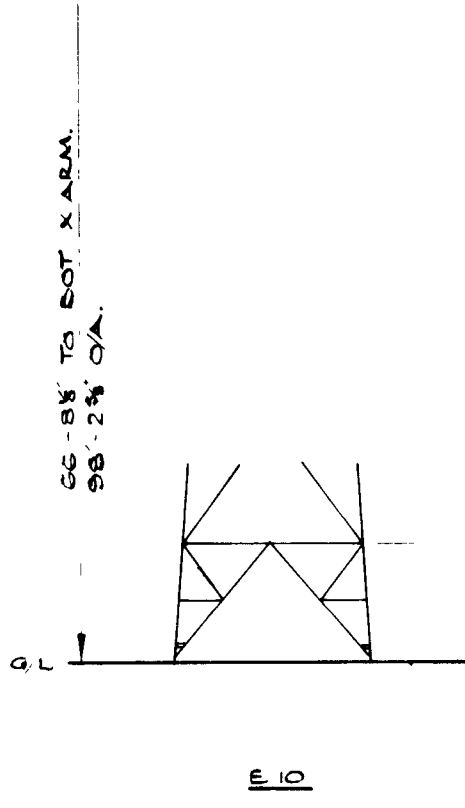
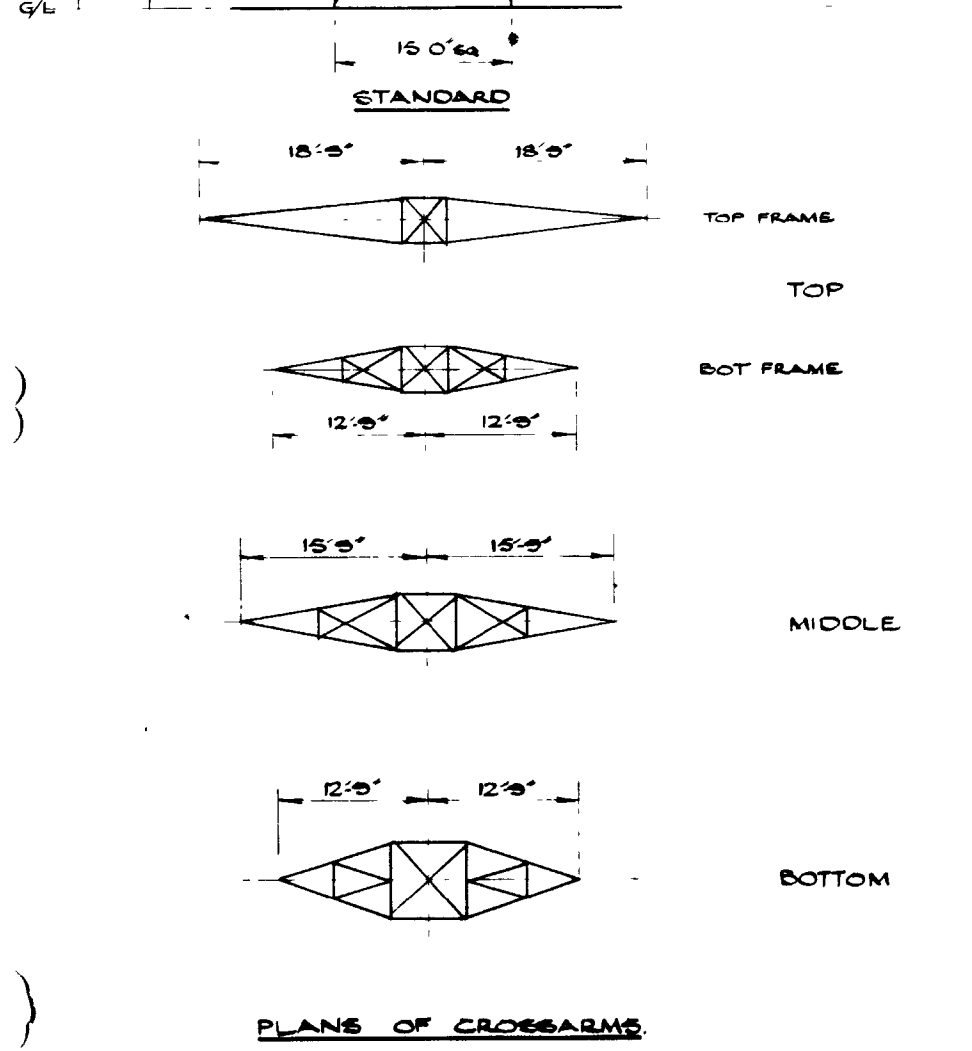
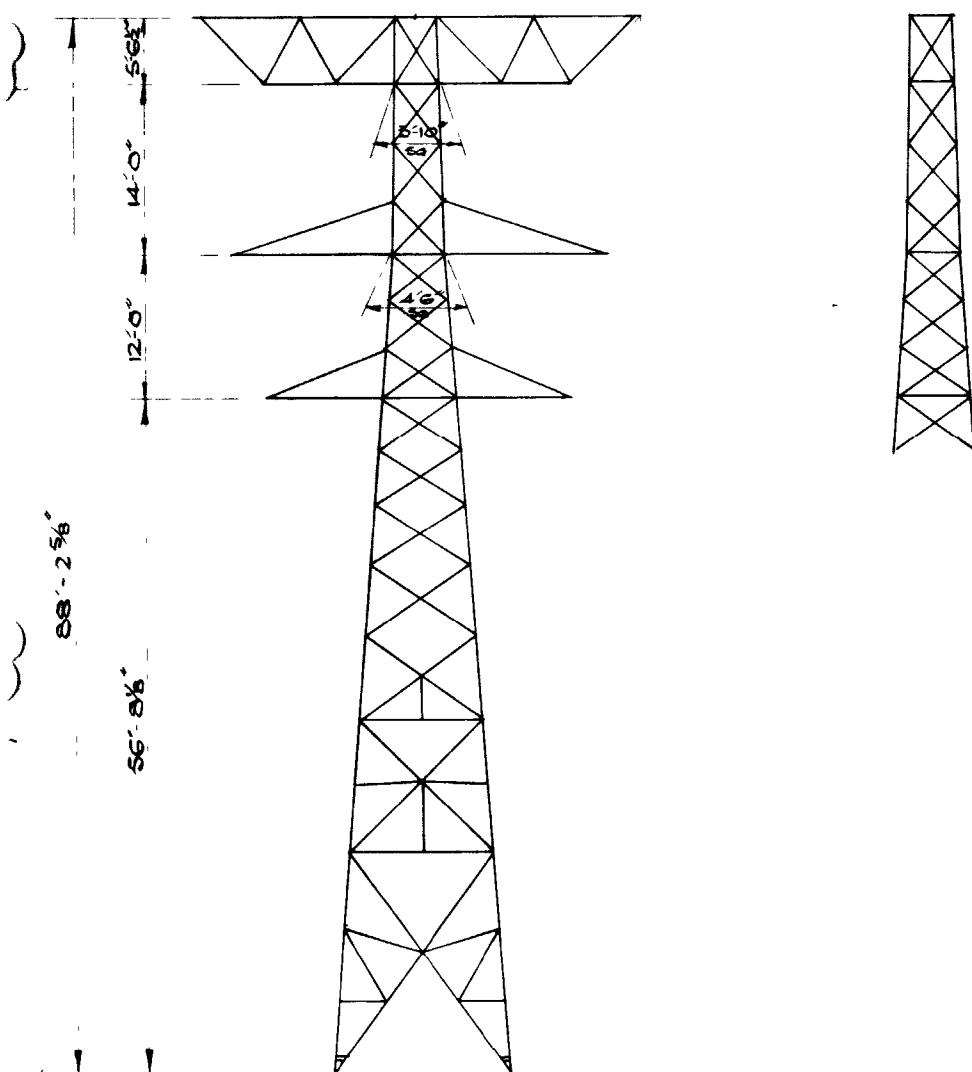

REF DWGS

	GEN ARRGT
STANDARD	35/1639
10'-0" EXT	35/1650
20'-0" & 30'-0" EXT	35/1661
40'-0" EXT	35/1640
70'-0" EXT	35/1686

DROPPER LENGTH 1'-0"

E 70
D.D. 2° TOWER. (WATSHAMS)
 DESIGN TYPE. S.E.E. PL. 7.
 SCALE:- 1/16" TO 1 FT

DRAWN	LWF	24 8 56
TRACED		

A

DRG. NO. ED. 51109.

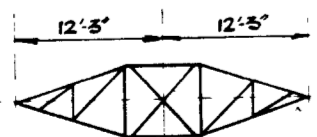
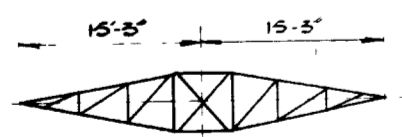
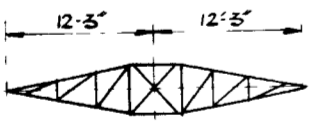
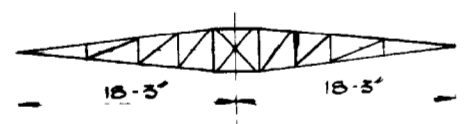
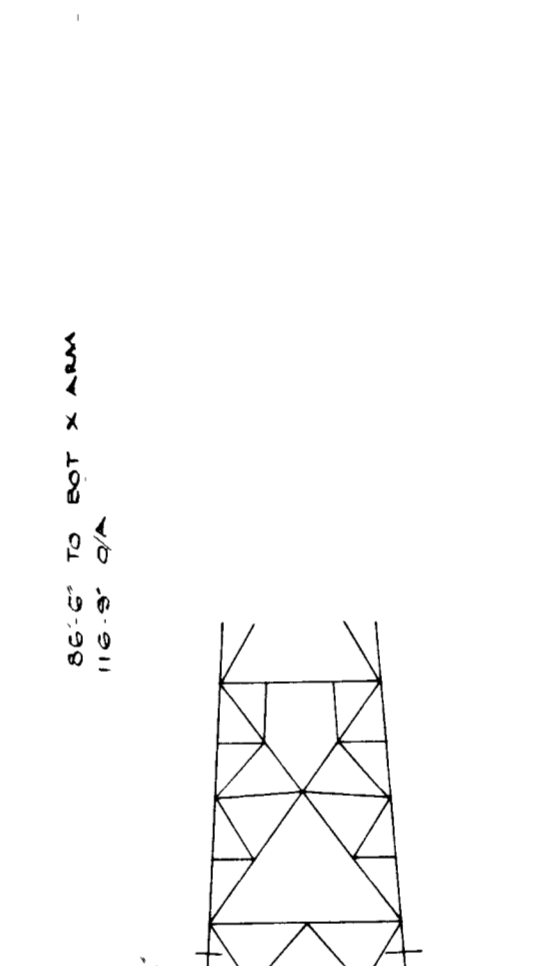
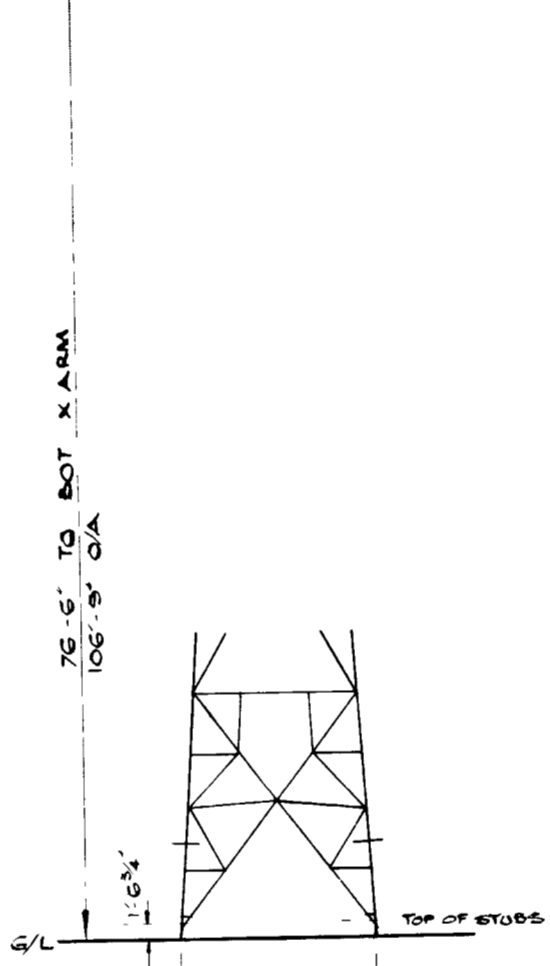
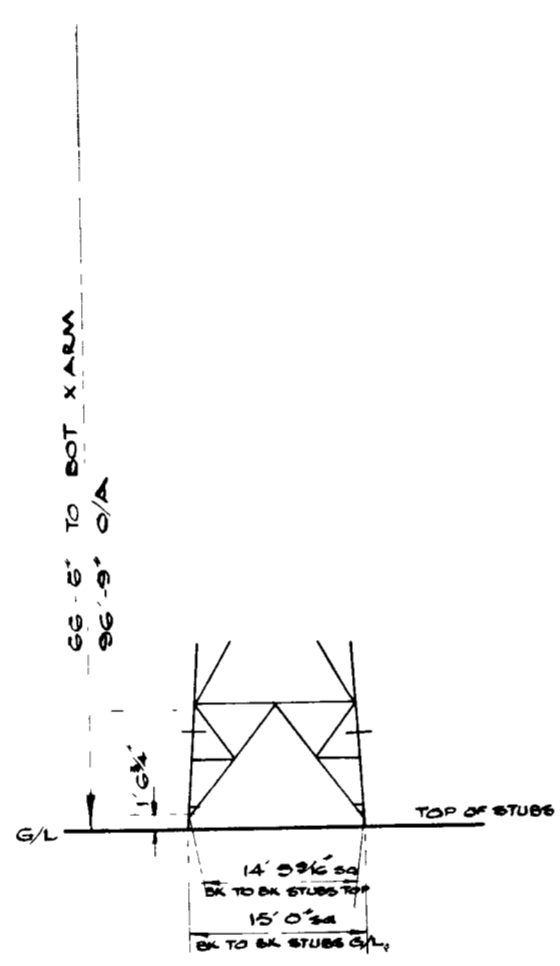
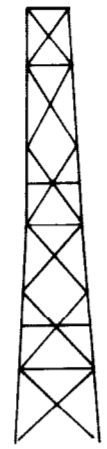
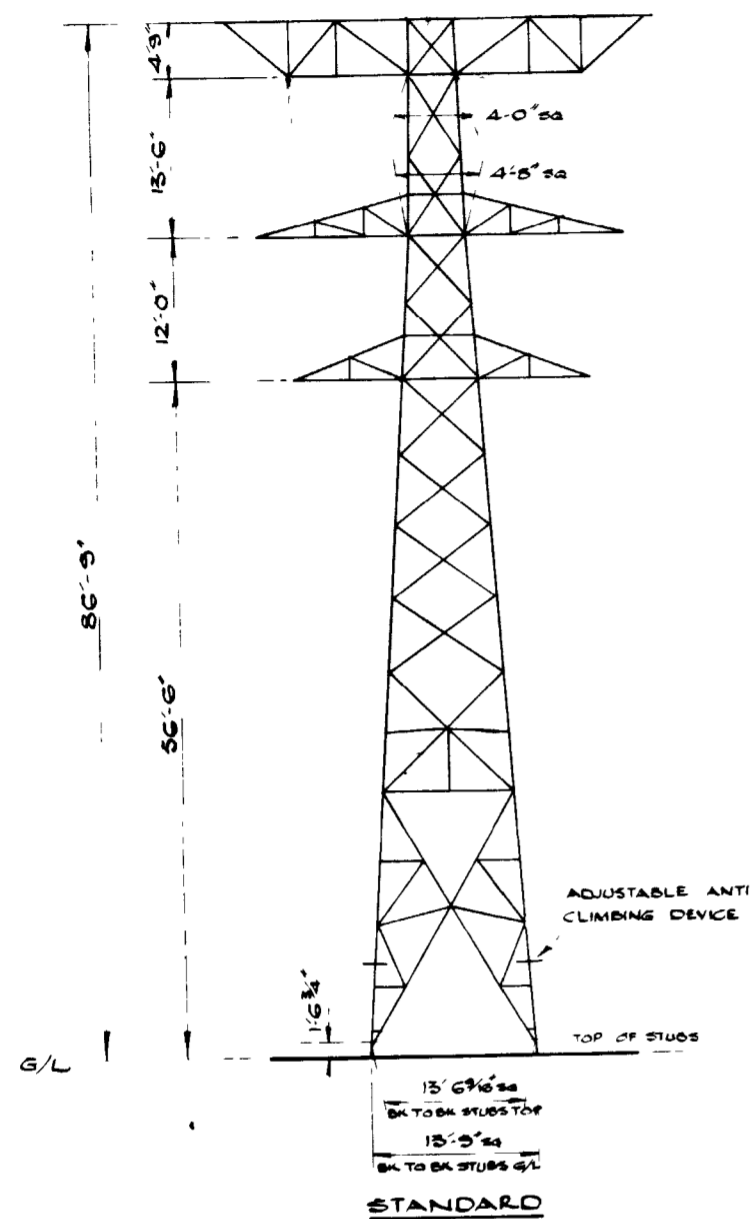

PLANE OF CROSSARMS

REF DRGS	GEN ASST	ERECTION
STANDARD	35/895	35/910
EXTENSIONS	35/824	35/917

DROPPER LENGTH 11'

D.D. 2° TOWER. (BLAW KNOX)
 DESIGN TYPE: S.W.E. P.L.16.

SCALE: 1/16" TO 1 FT

DRAWN LWF 26 5-56
 TRACED

A

DRG. NO. ED. 51110.

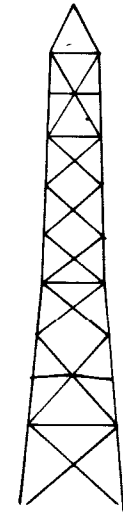
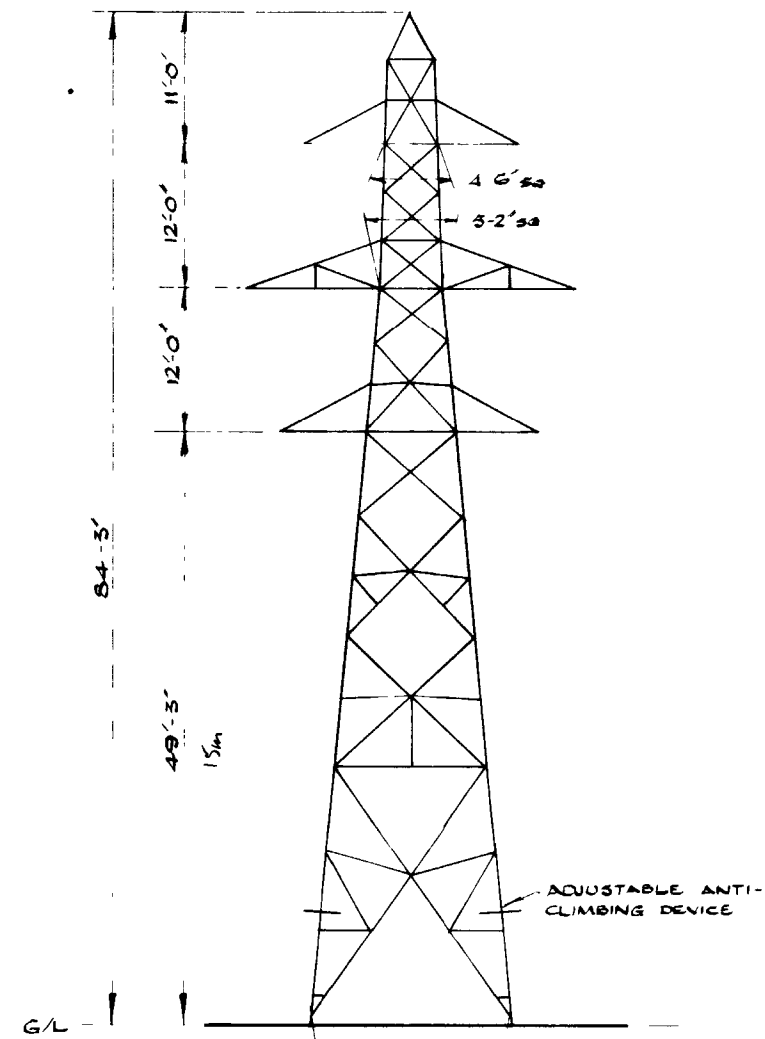

16'-7 3/8" sq
BK TO BK STUBS TOP
17'-0" sq
BK TO BK STUBS G/L
STANDARD

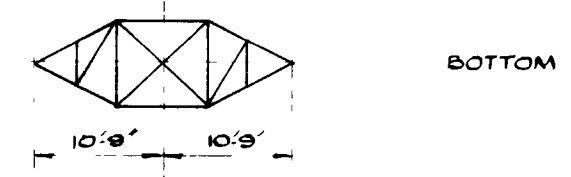
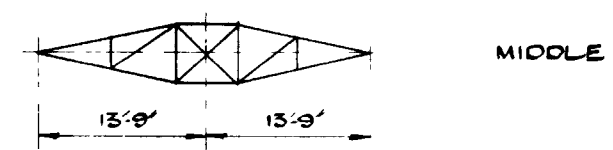
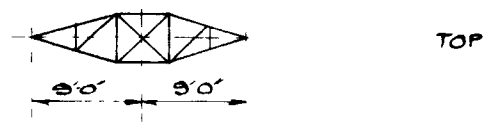

PLANS OF CROSSARMS

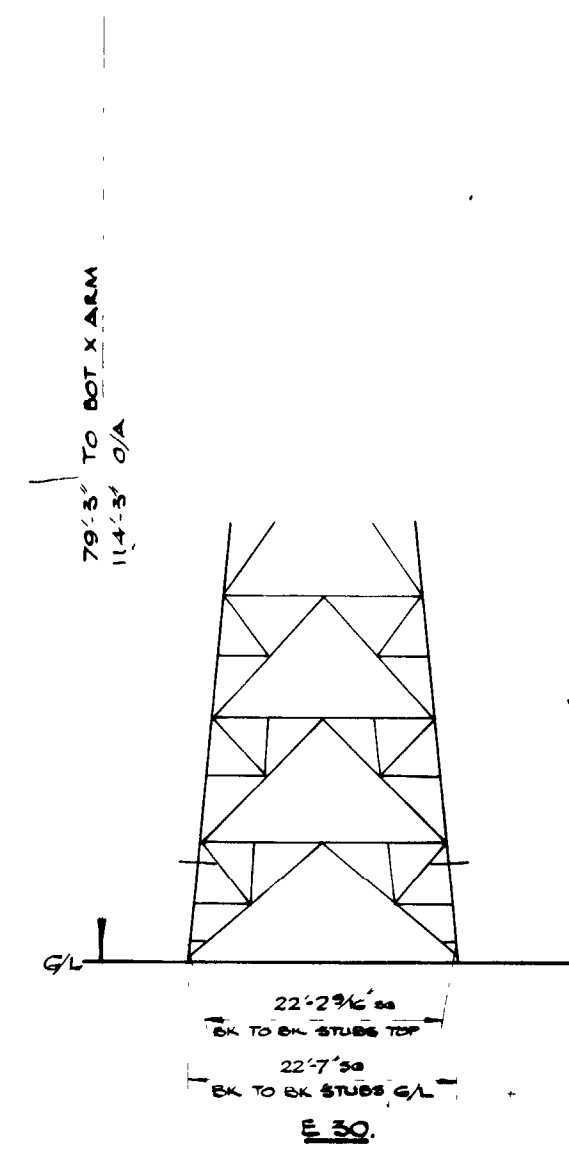
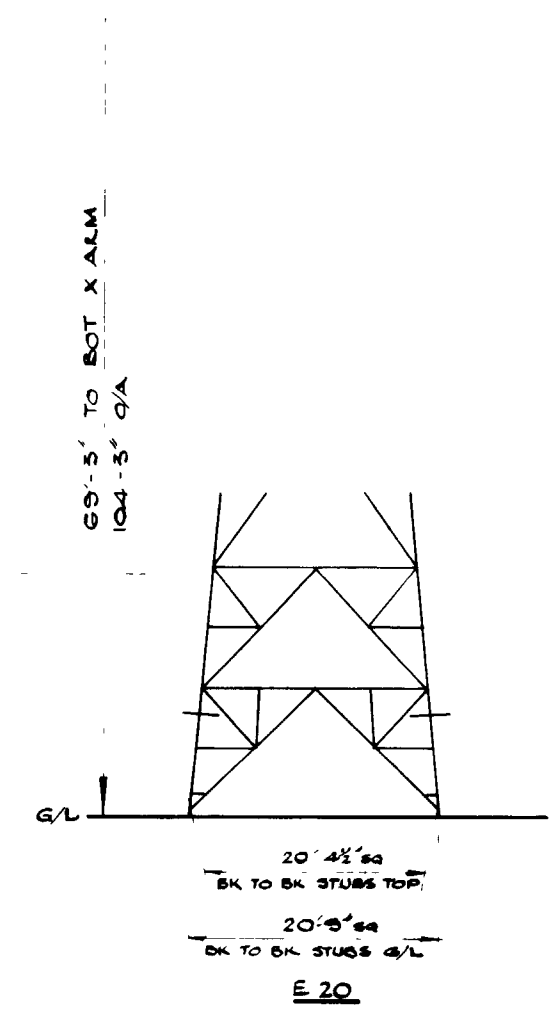
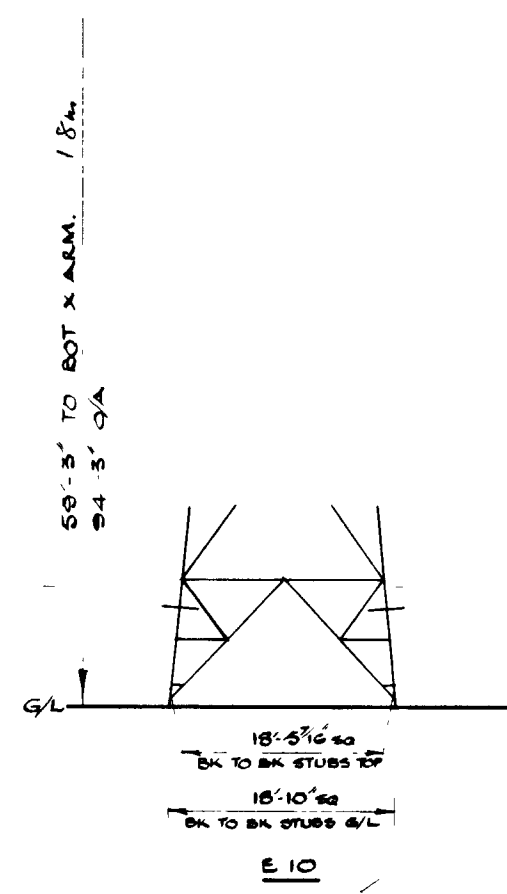

REF DRGS	GEN ARRGT	ERECTION
STANDARD	35/893	35/912
10' 20' 30' EXT	35/891	35/914

DRAWN	LWF	21 8 55
TRACED		
CHECKED		

A

D.10 TOWER. (BLAW KNOX)
DESIGN TYPE: SWE. PL. 16.

SCALE: 1/16" TO 1 FT

DRG. NO. ED. 51112

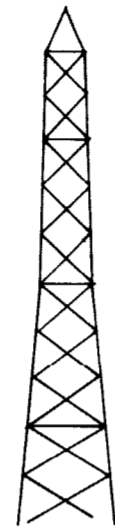
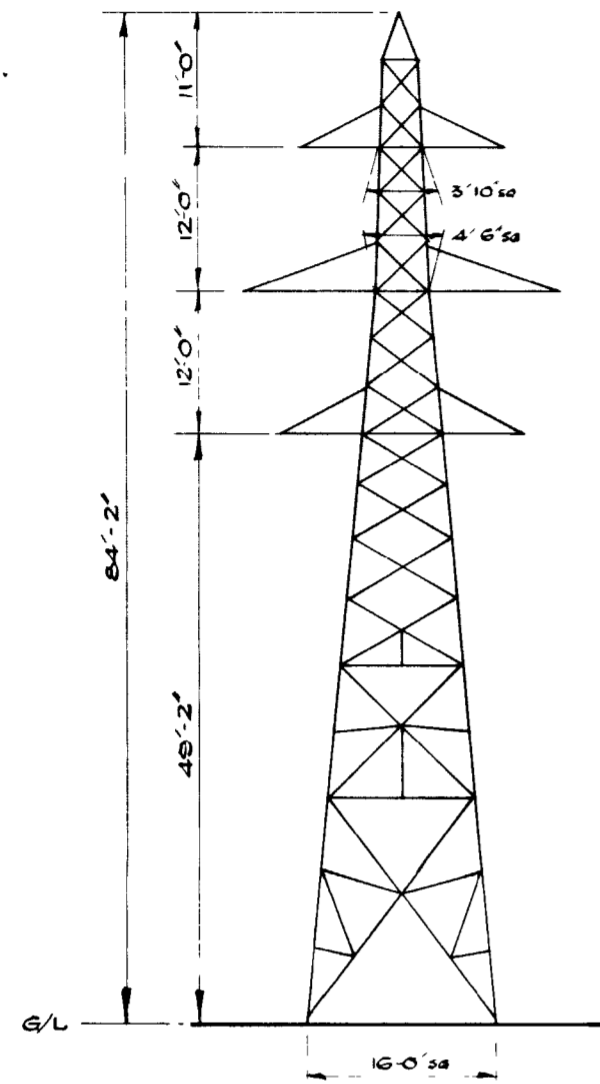

STANDARD

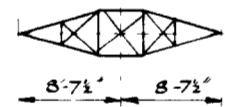

TOP

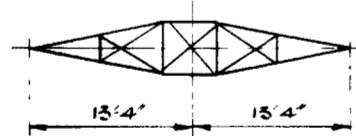

MIDDLE

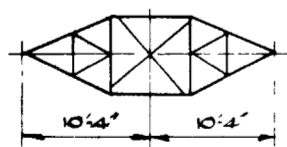

BOTTOM

PLANS OF CROSSARMS

REF ORGS

STANDARD

GEN ARGT
35/1658

D.10° TOWER. (WATSHAMS)
 DESIGN TYPE: S.E.E. P.L.7.

SCALE:- 1/16" TO 1 FT

DRAWN	LWF	51 8 66
TRACED		
CHECKED		

A

DRG. NO. ED.51113

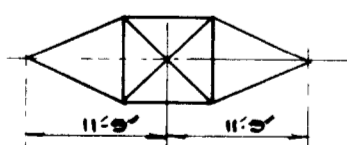
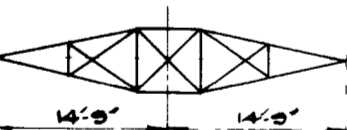
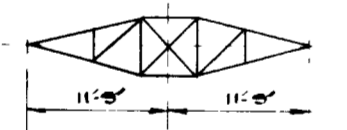
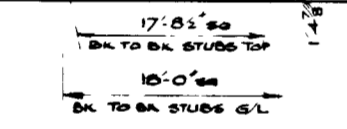
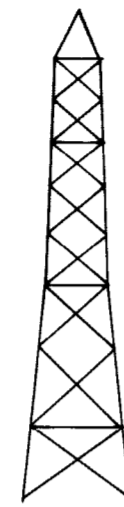
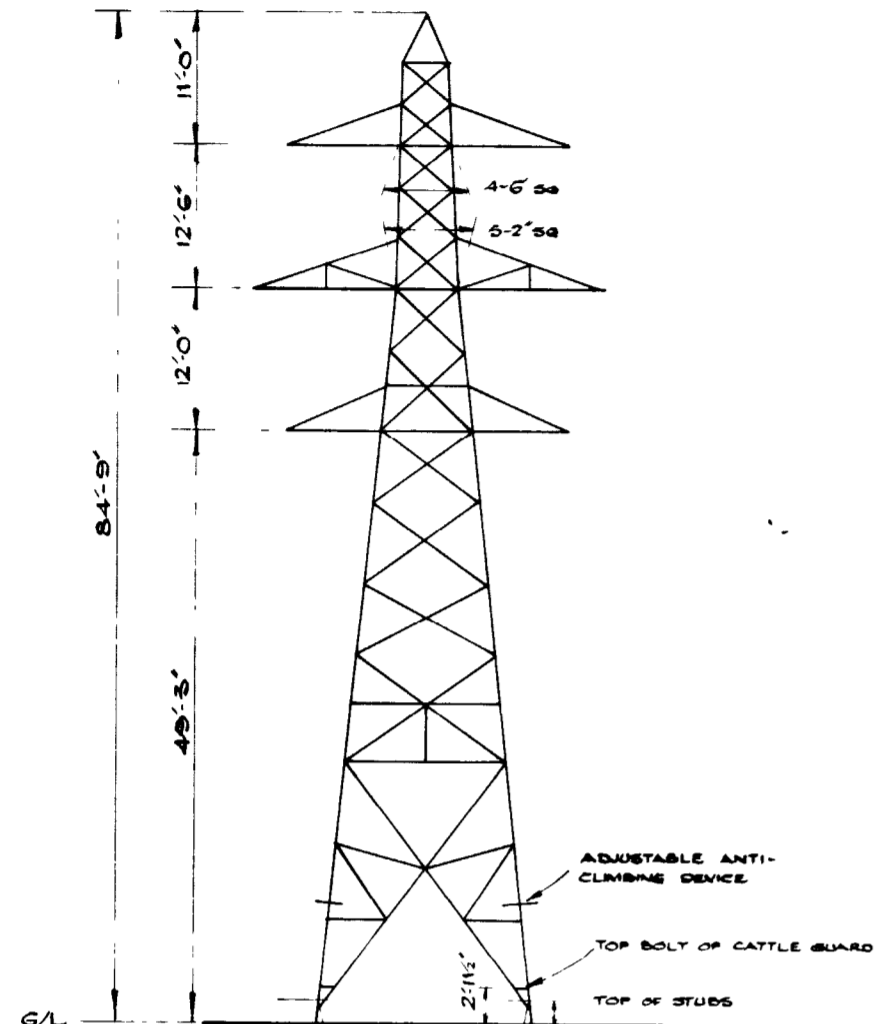

PLANS OF CROSSARMS.

59'-5" TO BOT X ARM
94'-9" O/A

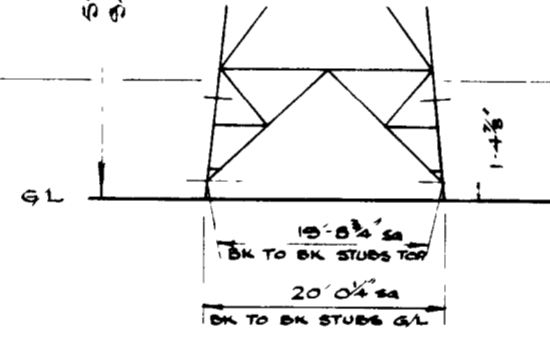

E 10

69'-3" TO BOT X ARM
104'-9" O/A

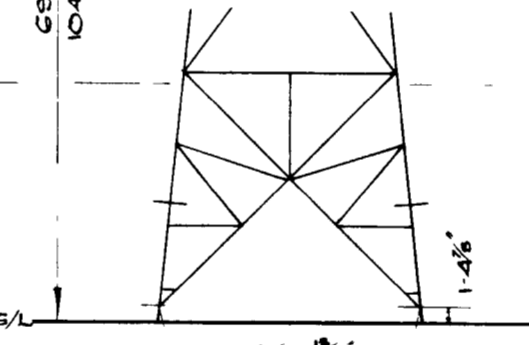

E 20

79'-3" TO BOT X ARM
114'-9" O/A

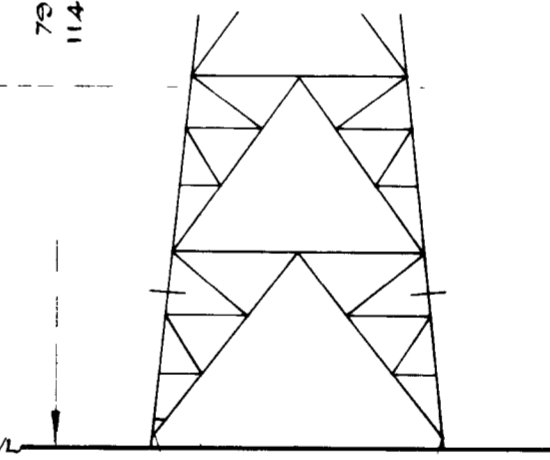

E 30

79'-3" TO BOT X ARM
114'-9" O/A

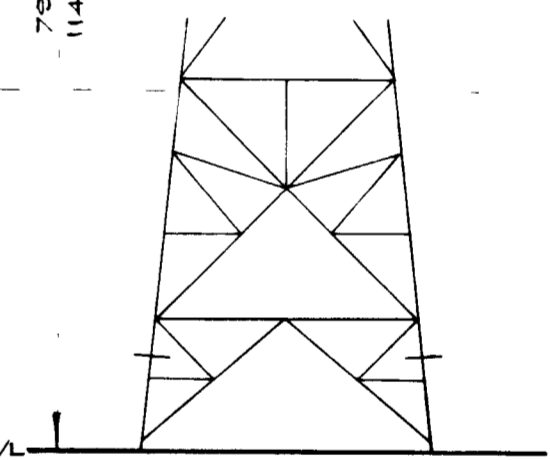

E 20 + 10'

REF DRGS	GEN ARGVT	ERECTION
STANDARD	35/1805 35/811	20/826
10' EXT	35/826	35/827
20' EXT	35/828	35/829
30' EXT		35/831
20' EXT + 10'	35/830	

D.10 TOWER. (BLAW KNOX)
DESIGN TYPE: C.E.P.L.A.

SCALE: 1/16" TO 1 FT

DRAWN	LWF	3084
TRACED		

A

DRG. NO. ED.51114

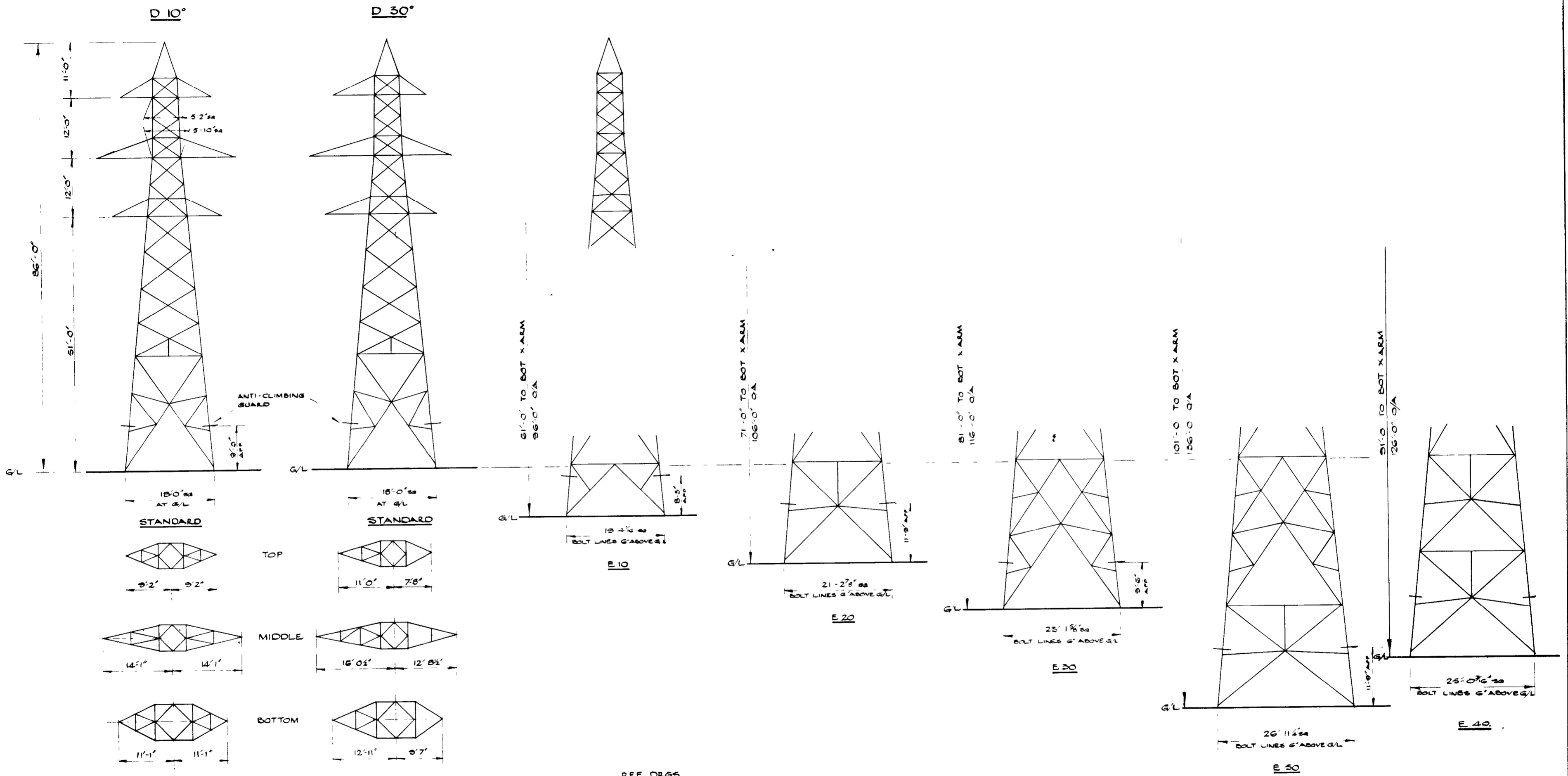

PLANE OF CROSSARMS

REF DRGS	GEN ARRGT
STANDARD	35/3516
CROSSARMS	35/3518
10' & 20' EXT	35/3525
30' EXT	35/3526
50' EXT	35/3525
40' EXT	35/3527

D.10° & D.30° TOWER.
 DESIGN TYPE. J.L.EVE.
 SCALE:- 1/4" TO 1 FT

DRAWN	LWF	20-3-56
TRACED		
CHECKED		

A		DRG. NO. ED.51115
---	--	-------------------

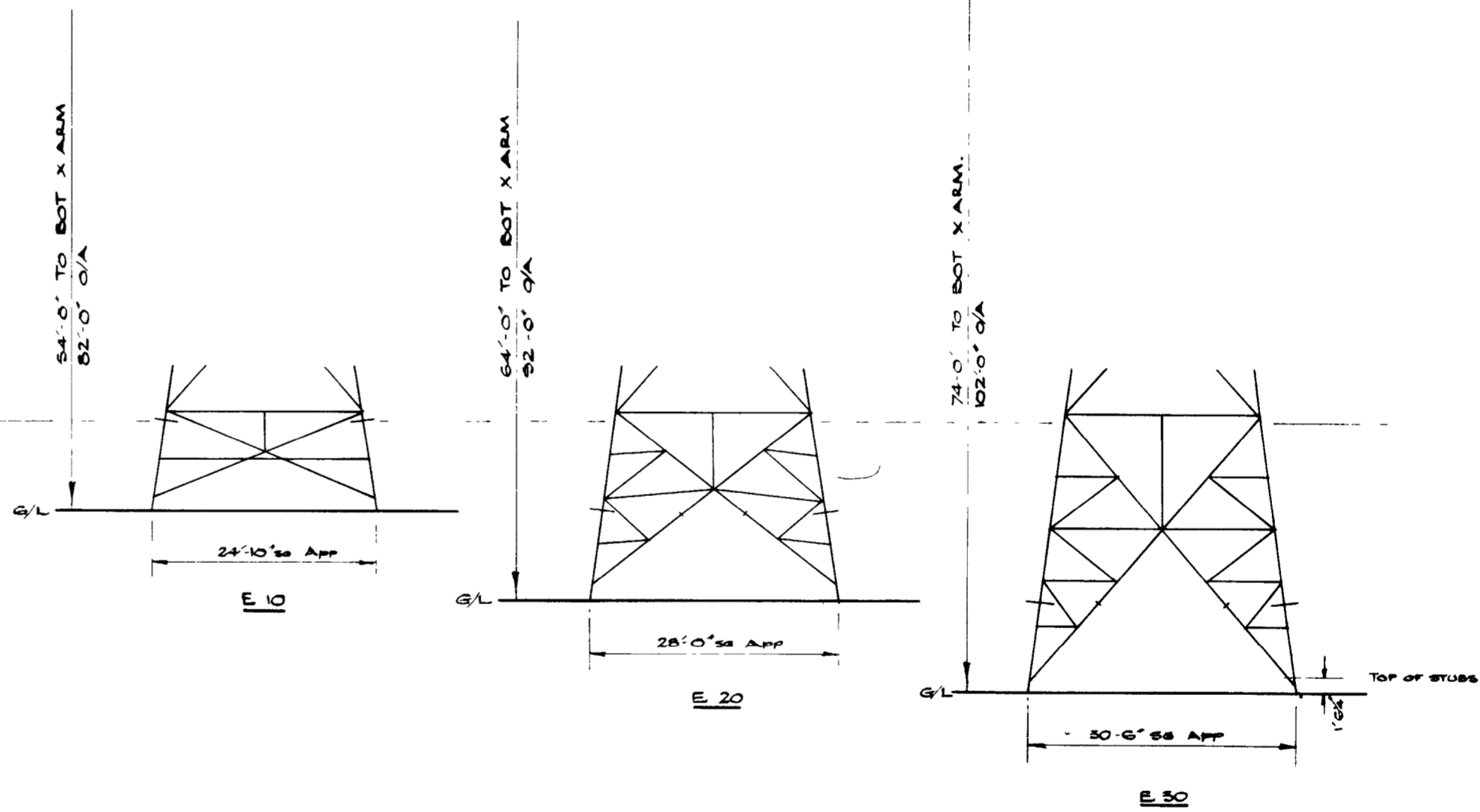
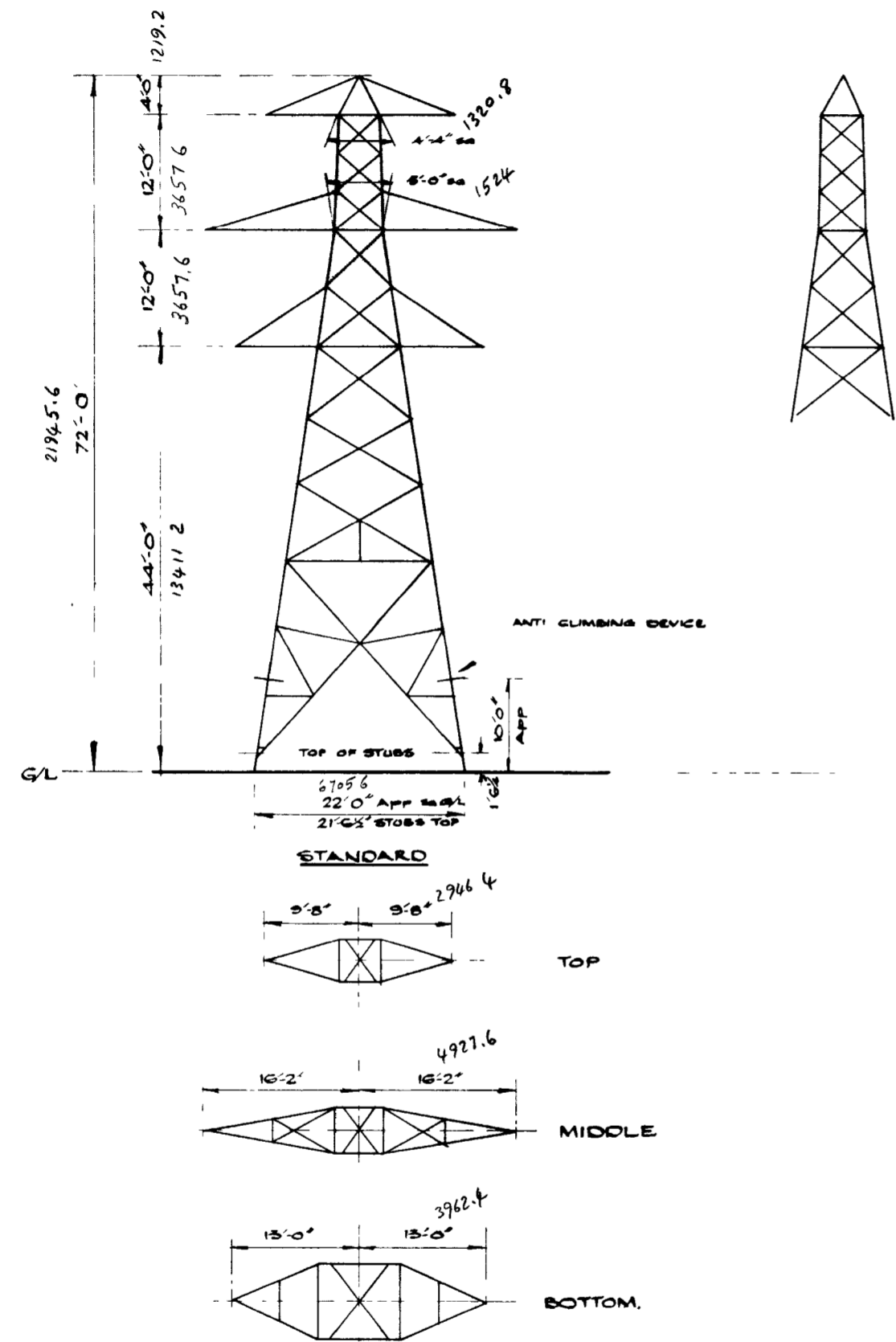

PLANS OF CROSSARMS

REF DRGS	GEN ARRGT	ERECTION
STANDARD	35/1727 35/1944	35/1291
10' 20' EXT	35/1945	
30' EXT	35/1204	35/716

D.30° TOWER. (MILLIKEN)
 DESIGN TYPE: E.E.P.L.I.

SCALE: 1/8" TO 1 FT.

DRG. NO. **ED. 51119.**

DRAWN	LWF	5 9 36
TRACED		
CHECKED		

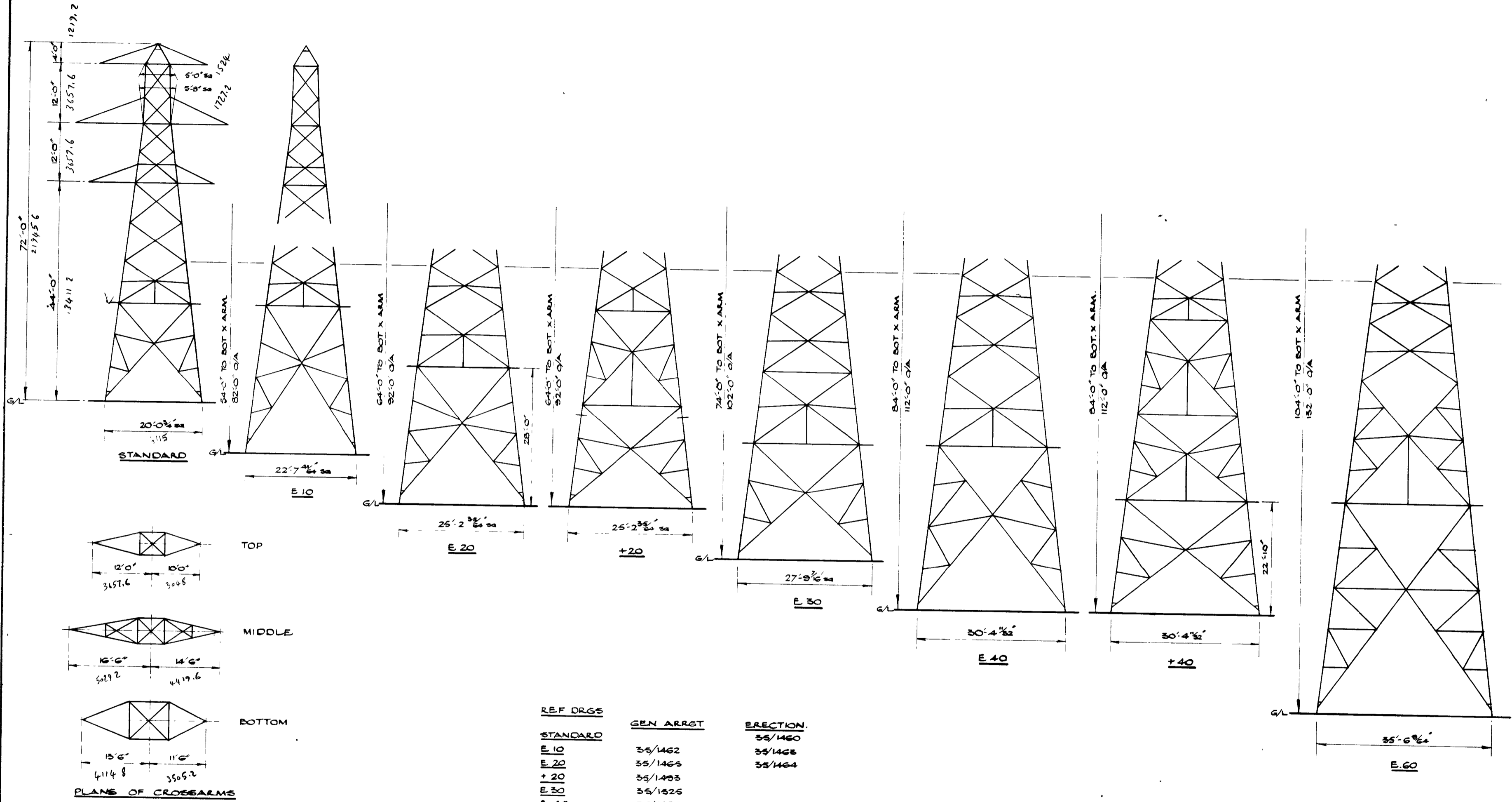

REF DRGS	GEN ARRET	ERECTION
STANDARD		35/1460
E.10	35/1462	35/1463
E.20	35/1465	35/1464
+20	35/1493	
E.30	35/1525	
E.40	35/1498	
+40	35/1528	
E.60	35/1527 35/1528	

NOTE: CONTRACT SEE PL1 TOWER SIMILAR TO SEE PL1A
 SEE DRG NOS 35/1461 & 35/4835

D.30° TOWER. (PIRELLI)
 DESIGN TYPE: SEE PL.1A.
 SCALE:- 1/8" TO 1 FT
 DRG. NO. **ED.51120.**

DRAWN	LWP	7-9-85
TRACED		
CHECKED		

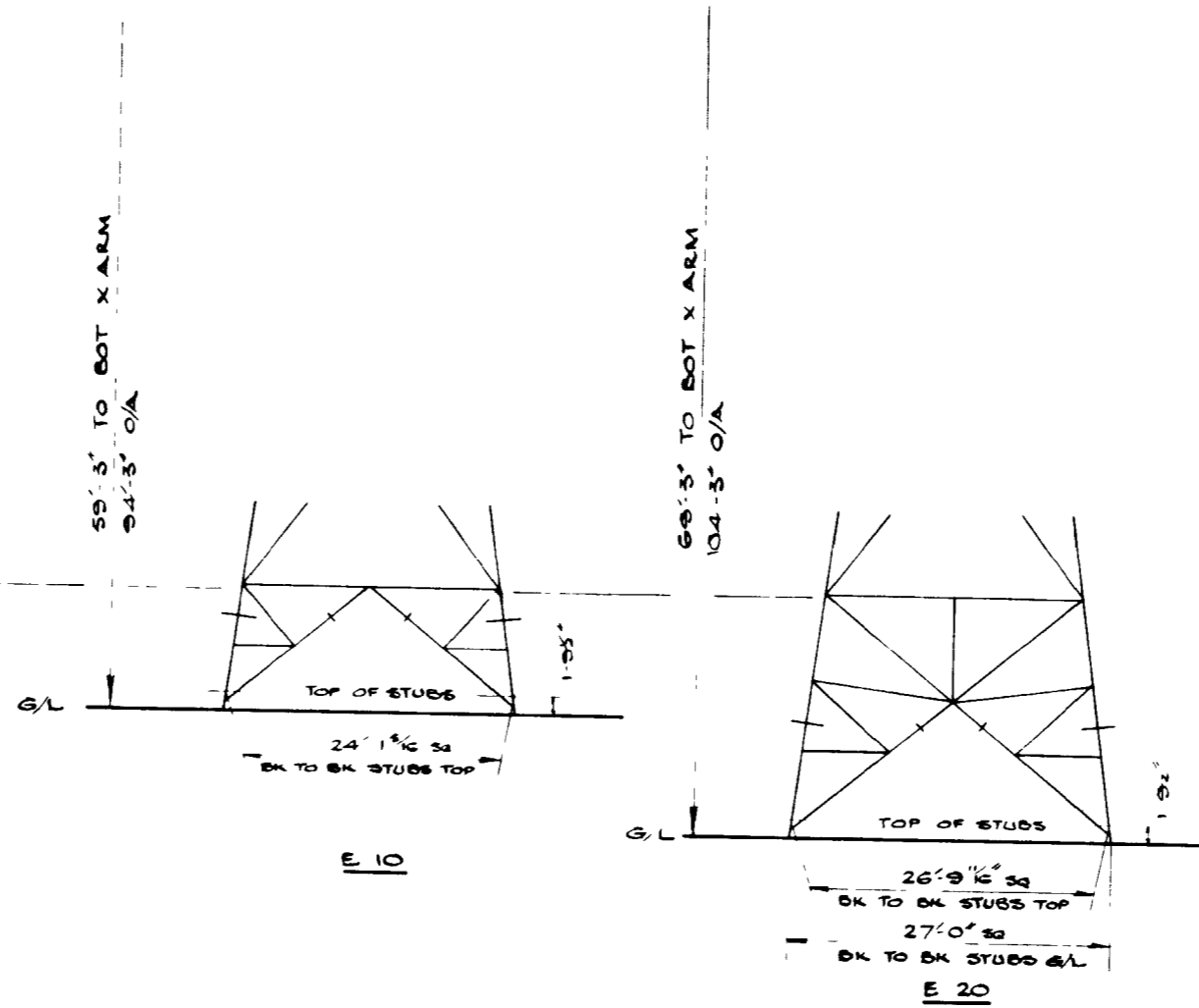
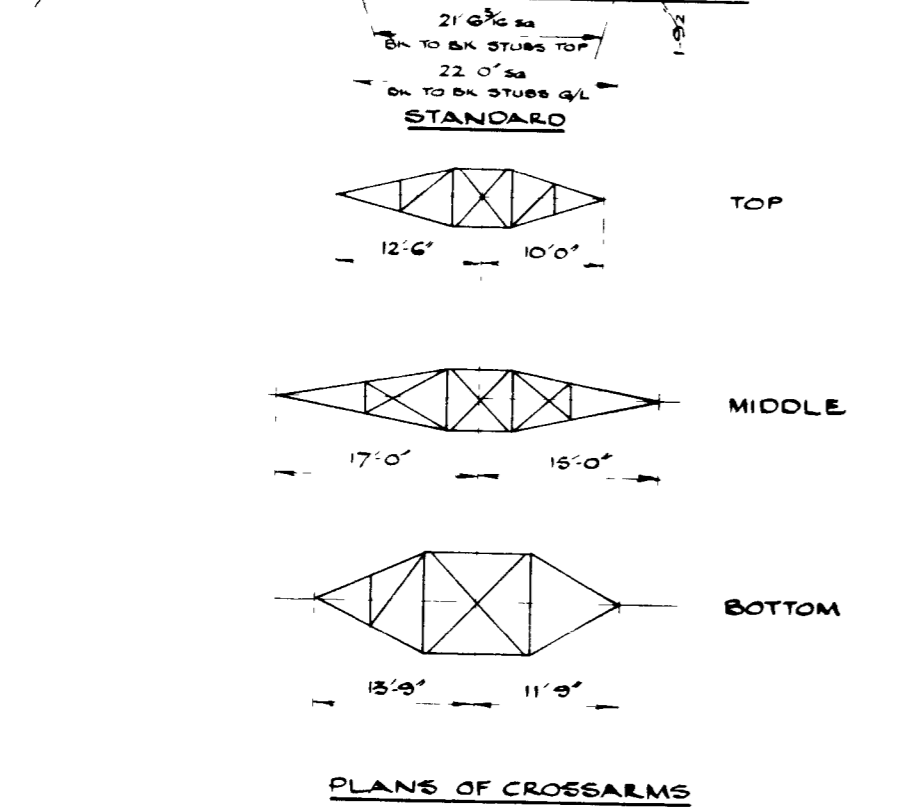
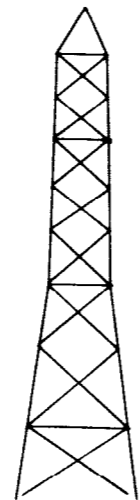
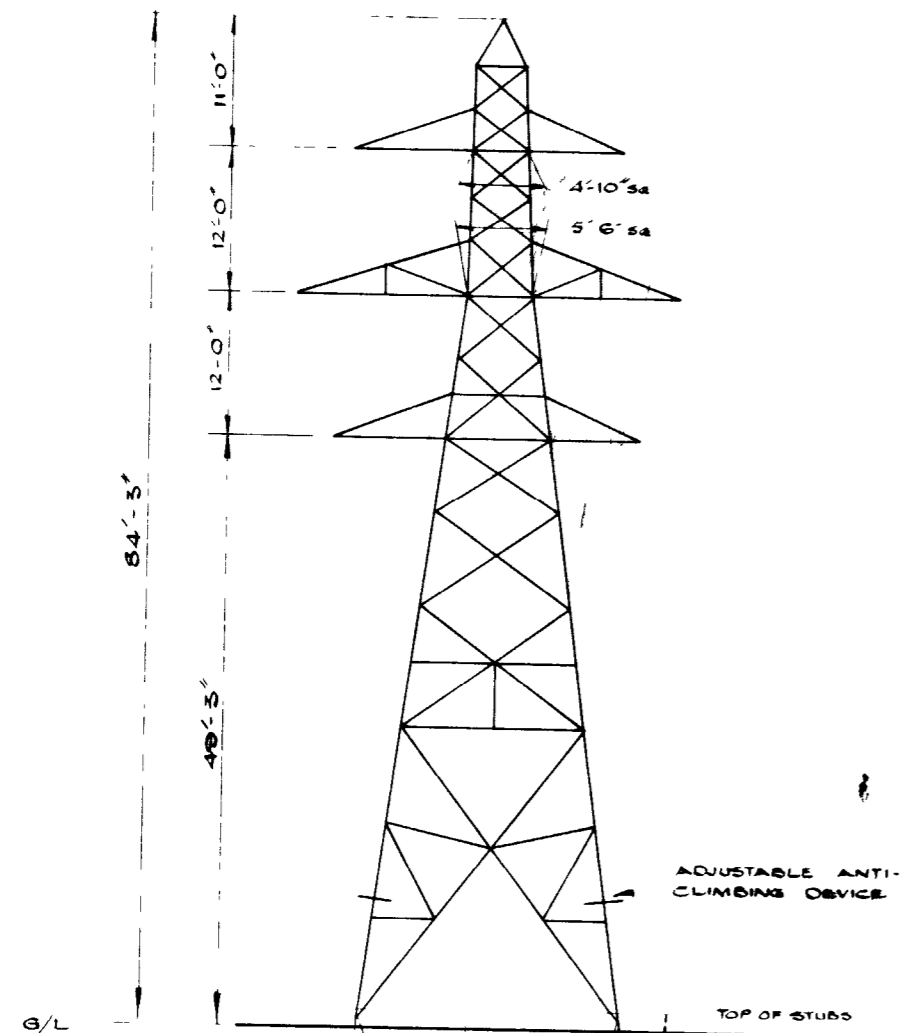

REF DRGS	GEN ARREST	ERECTION
<u>STANDARD</u>	35/812 35/1315	35/832
10' EXT	35/855	
20' EXT	35/855	35/836

DRAWN	LWF	S-D 56
TRACED		
CHECKED		

D.30° TOWER.(BLAW KNOX)
DESIGN TYPE: C.E.PL.4.

SCALE:- 1/16" TO 1 FT

DRG. NO. ED.51121.

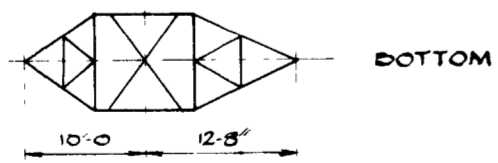
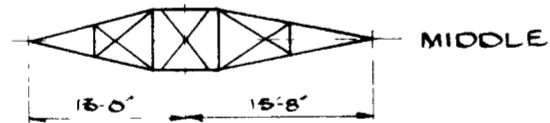
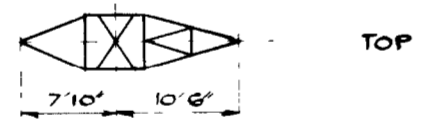
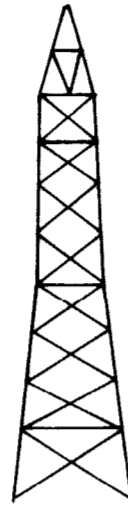
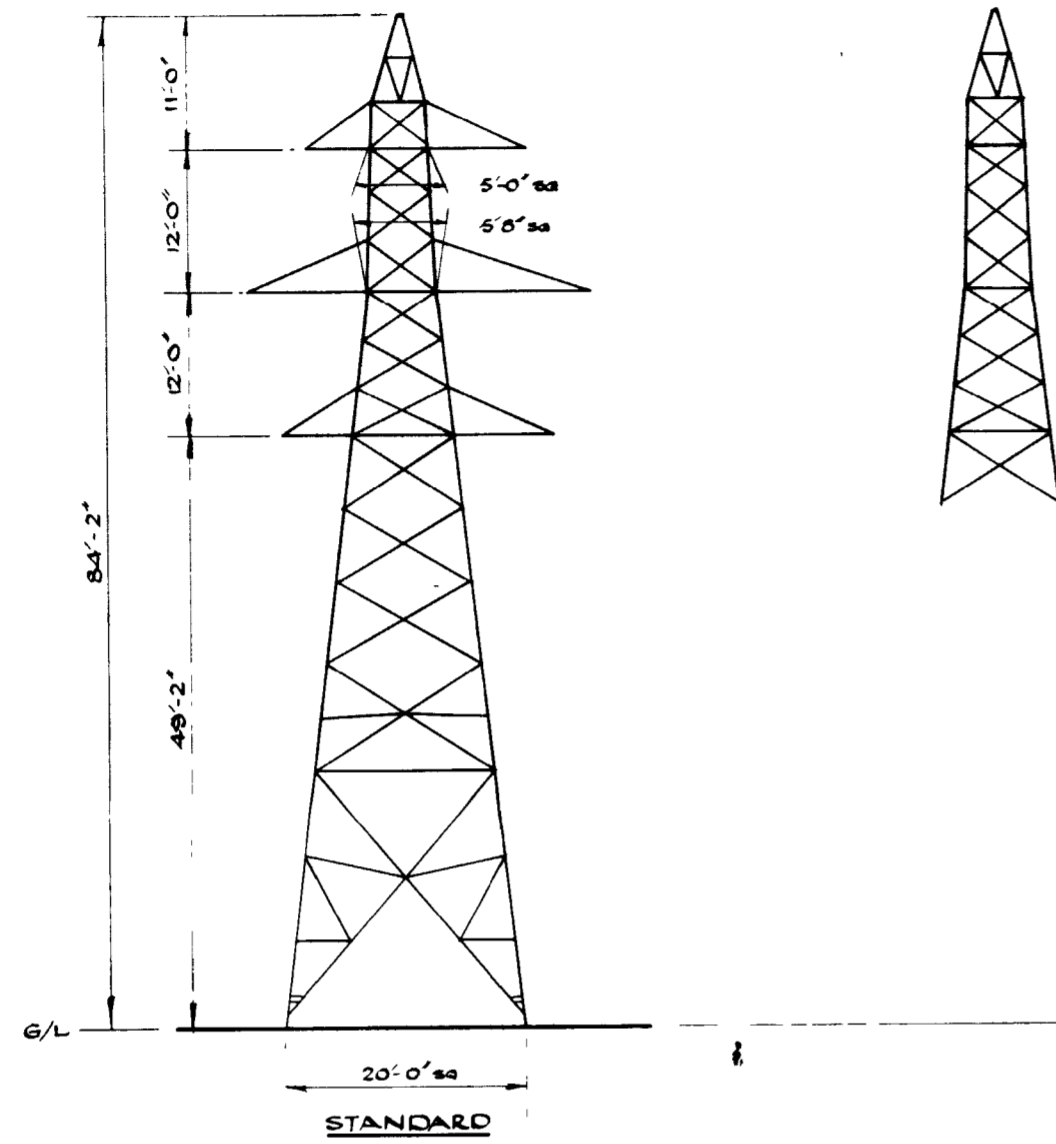

PLANS OF CROSSARMS

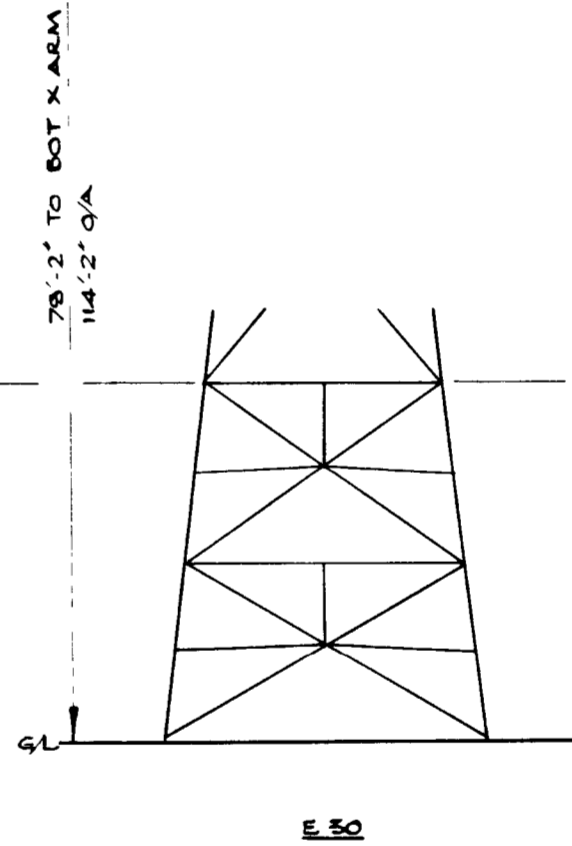
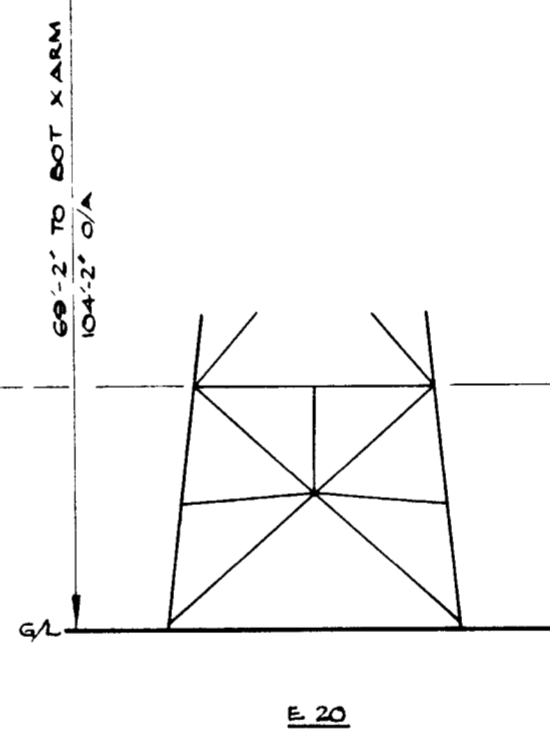
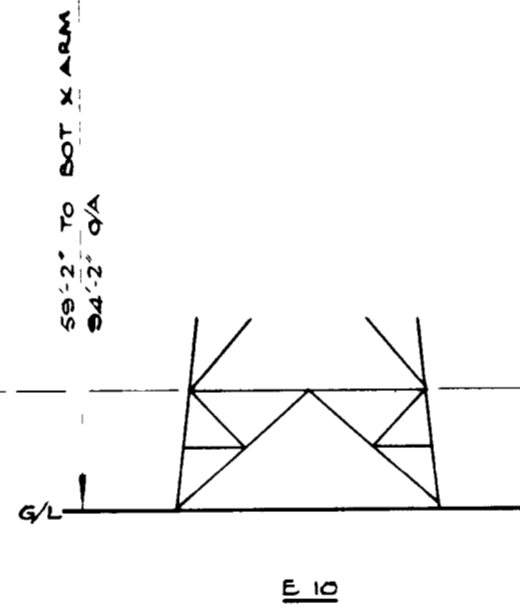

REF DRGS.	GEN ARGT
STANDARD	35/1004
10' 20' EXT	35/1005
30' EXT	35/1006

D.30° TOWER (WATSHAMS)
 DESIGN TYPE: S.E.E. PL.7

SCALE:- 1/8" TO 1 FT.

DRG. NO. **ED. 51122.**

DRAWN	LWF	G 3-50
TRACED		
CHECKED		

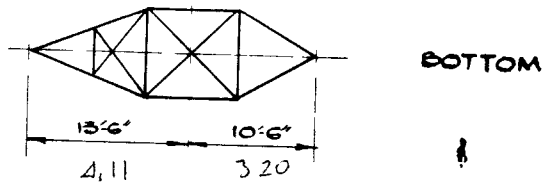
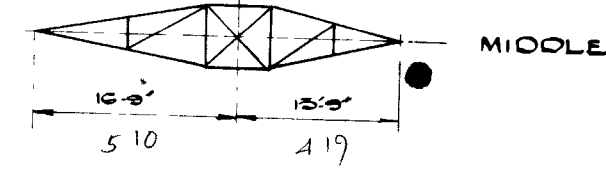
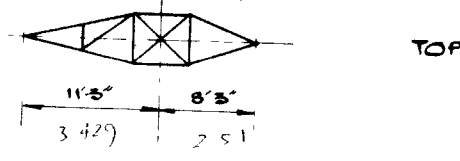
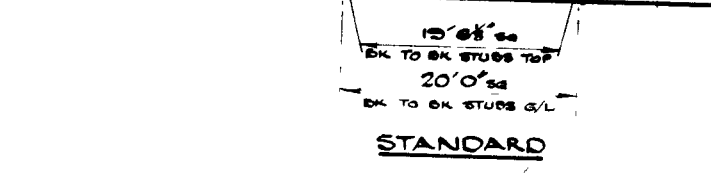
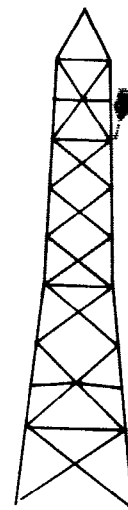
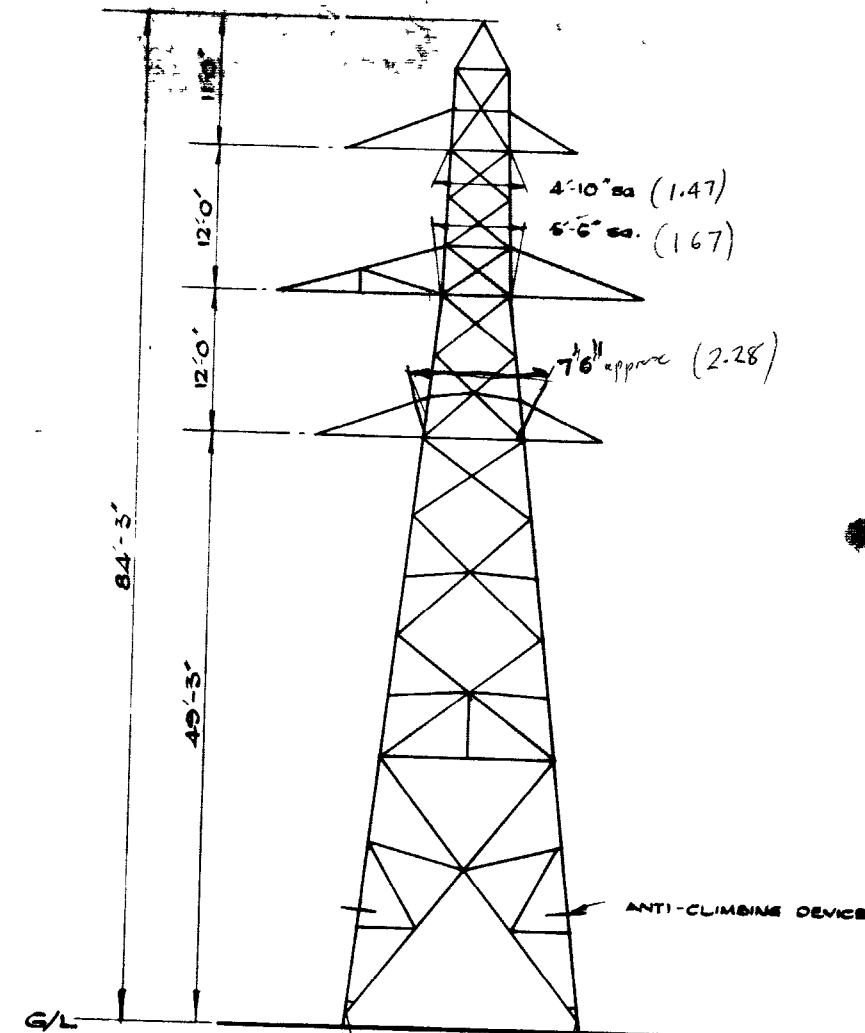

PLANS OF CROSSARMS

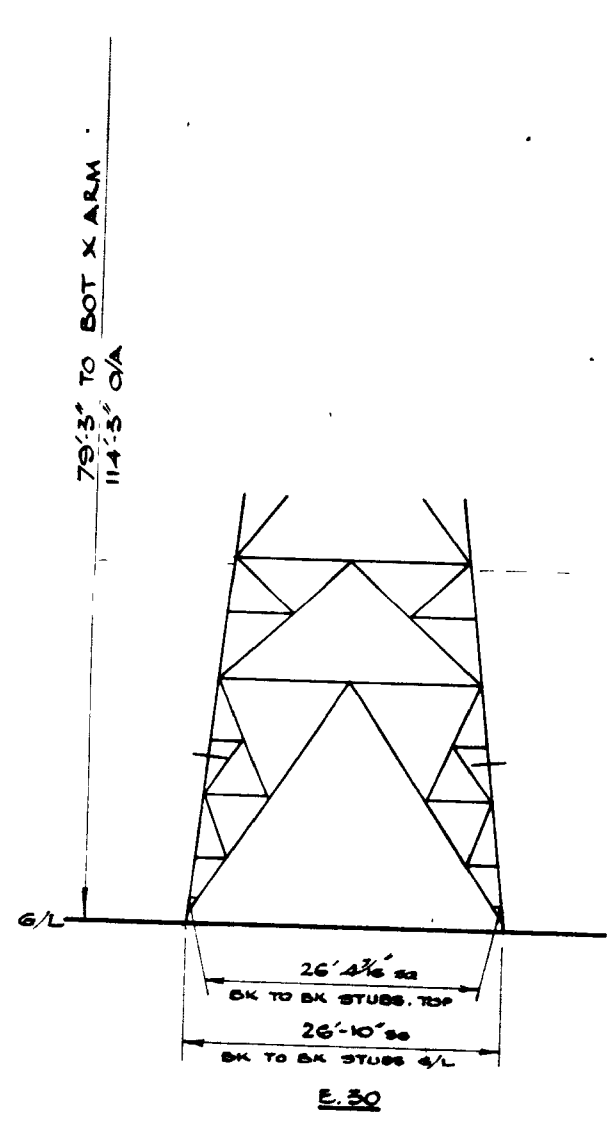
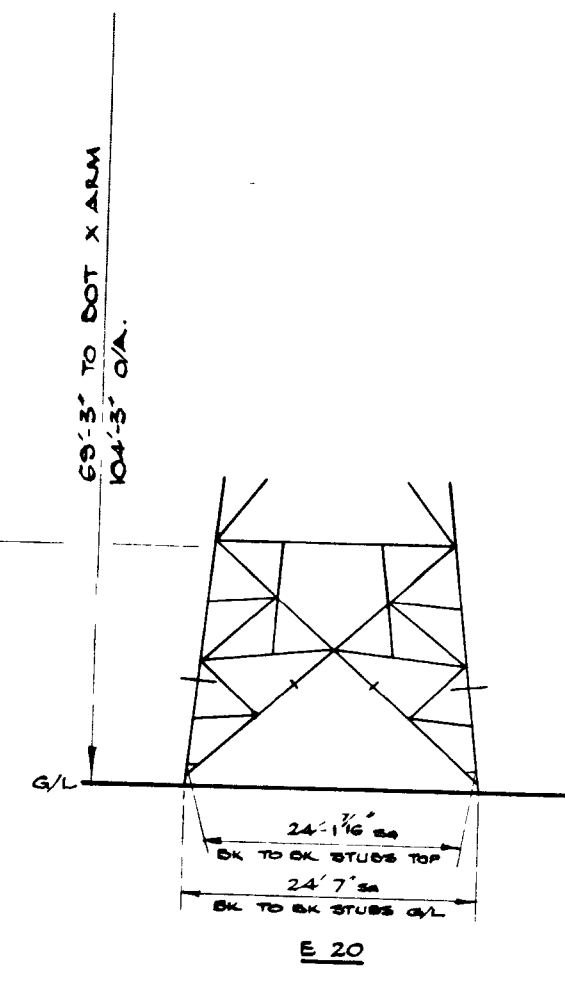
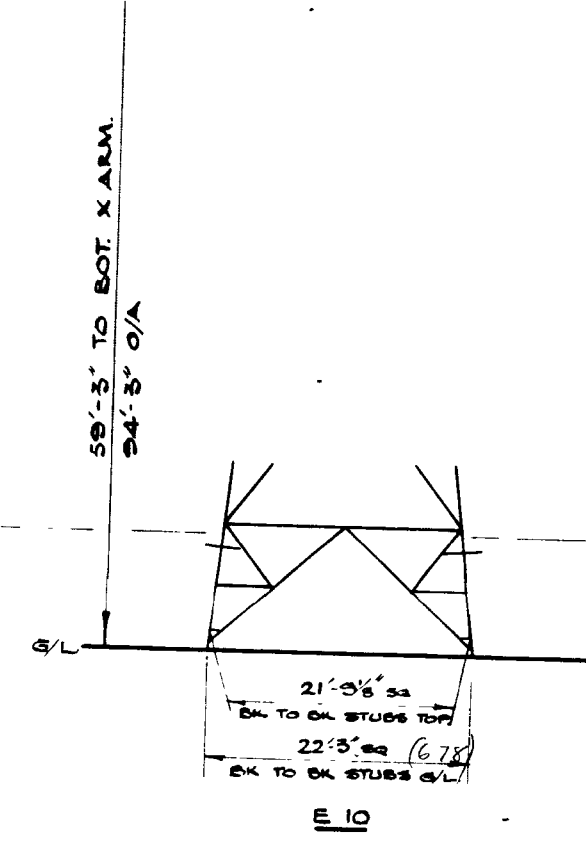

REF DRGS:	GEN ARRGT	ERECTION
STANDARD	35/892	35/824
CROSSARMS	35/890	35/833
10' 20' 30' EXT	35/883	35/832

DRAWN	LWF	S	SG
TRACED			
CHECKED			

D.30° TOWER. (BLAW KNOX)
 DESIGN TYPE: S.W.E. PL.16.
 SCALE: 1/16" TO 1 FT.
 DRG. NO. **ED.51123.**

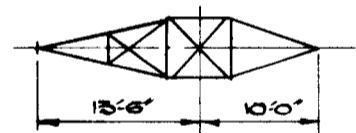
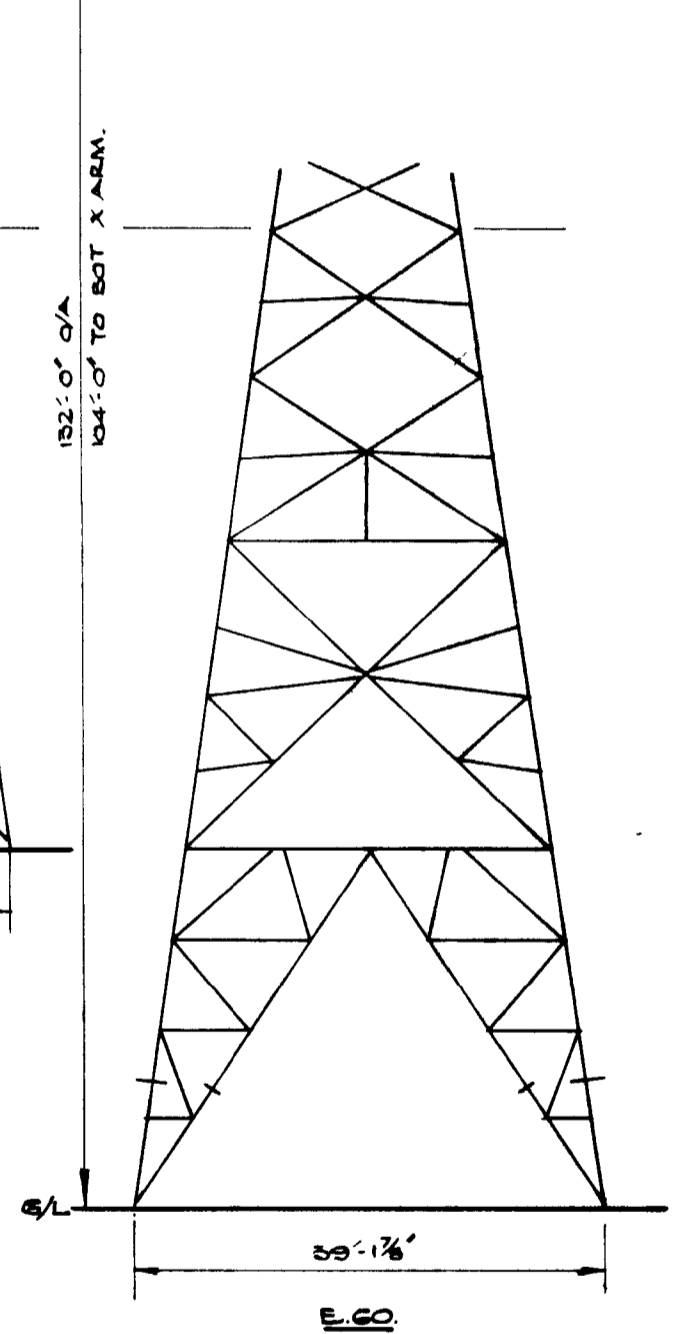
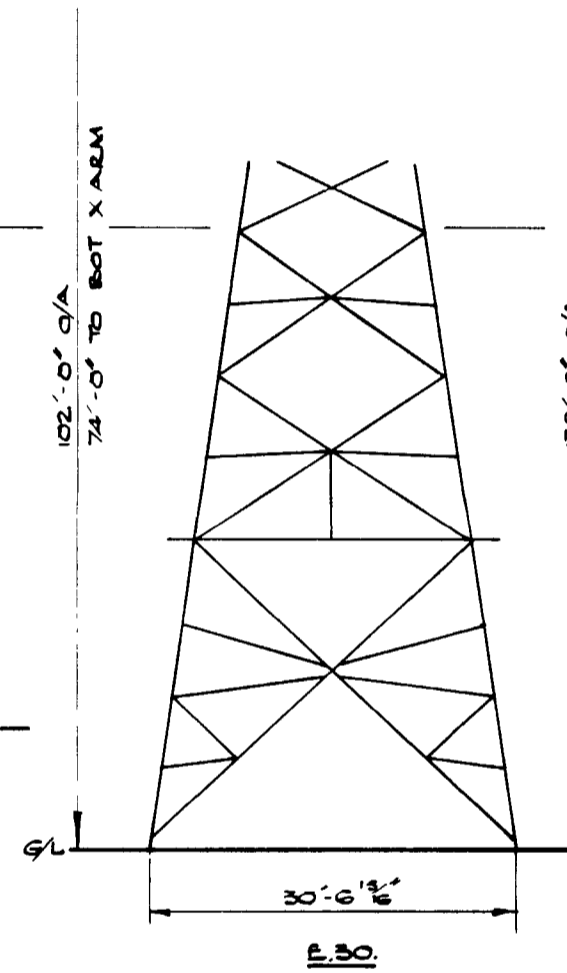
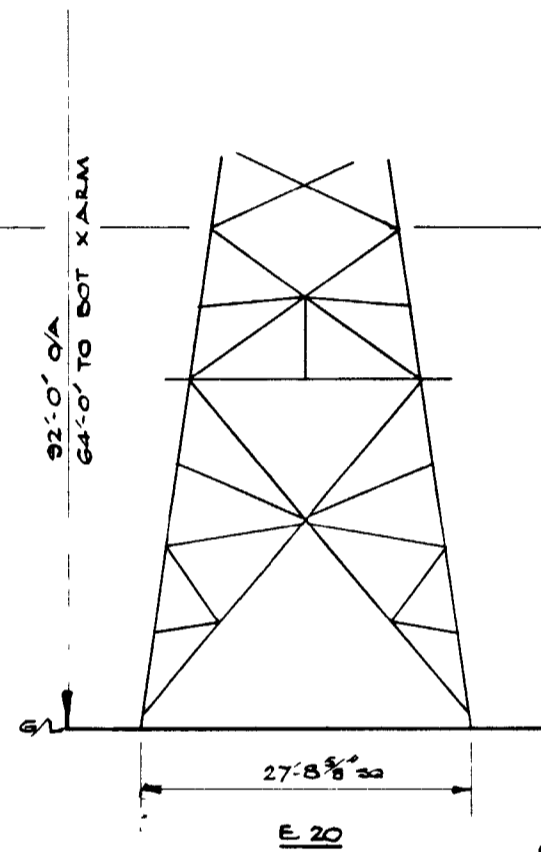
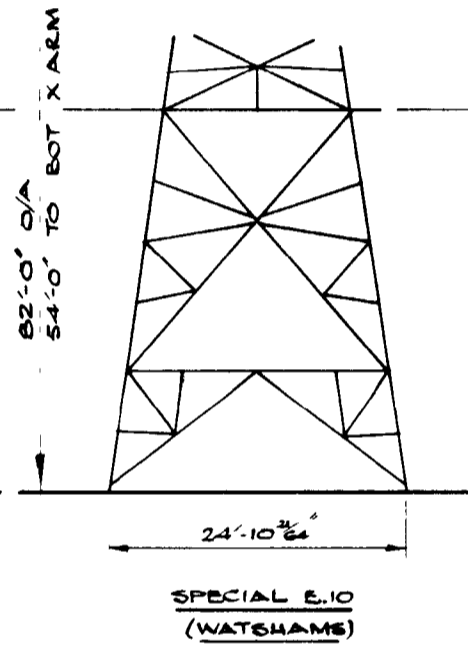
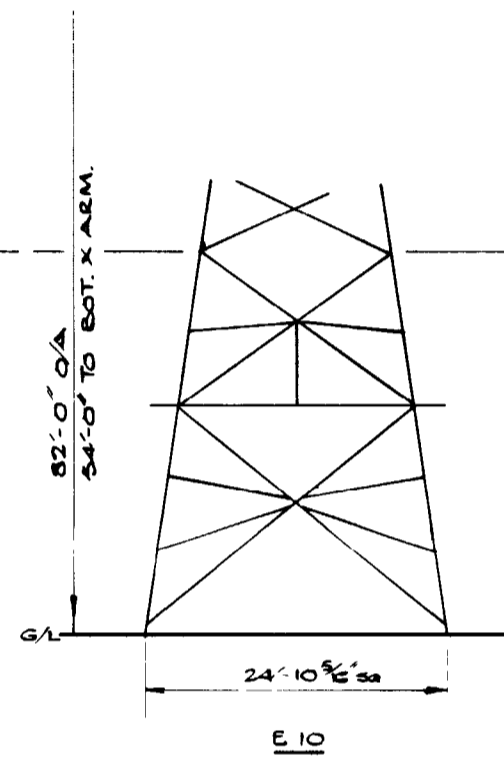
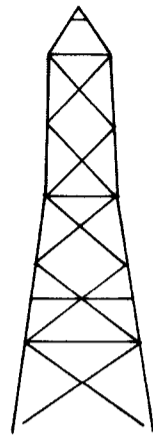
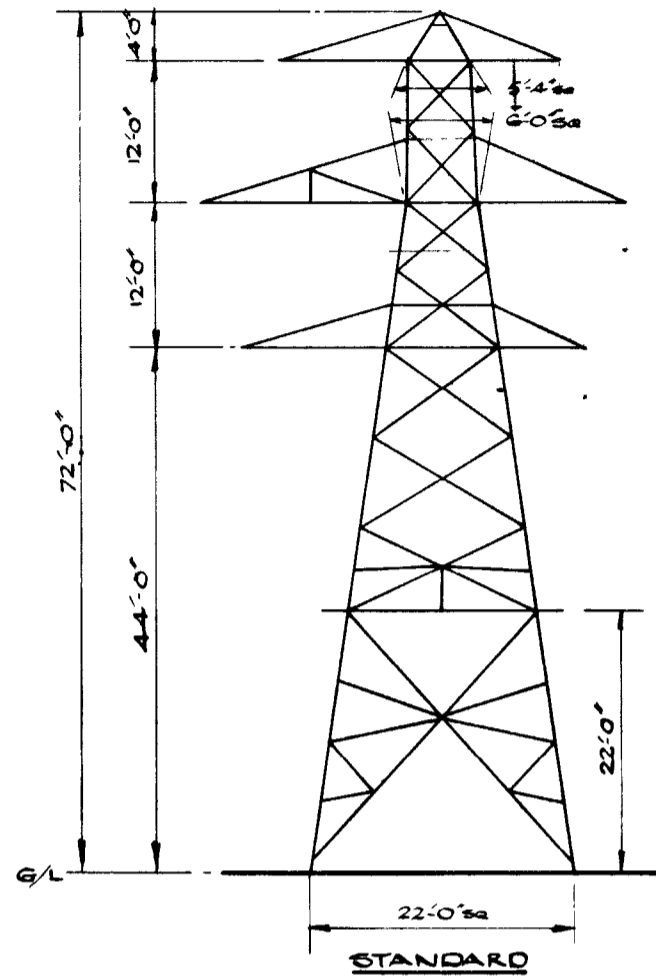

TOP

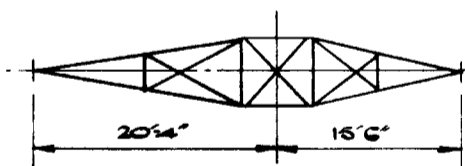

MIDDLE

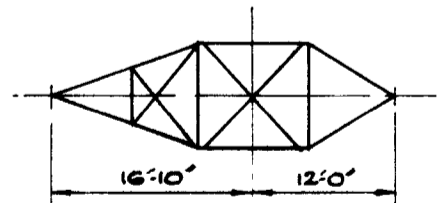

BOTTOM

PLANS OF CROSSARMS

REF DRGS.	
STANDARD	35/1466
E.10	35/1467
SPECIAL E.10	35/1500
E.20	35/1468
E.30	35/1517
E.60	35/1500 35/1501

D.60° TOWER. (PIRELLI)
 DESIGN TYPE: SEE PL.1A.
 SCALE: 1/16" = 1 FT.

DRAWN	LWF	25 25
TRACED		
CHECKED		

DRG. NO. **ED.51129.**

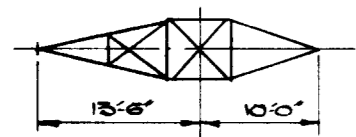
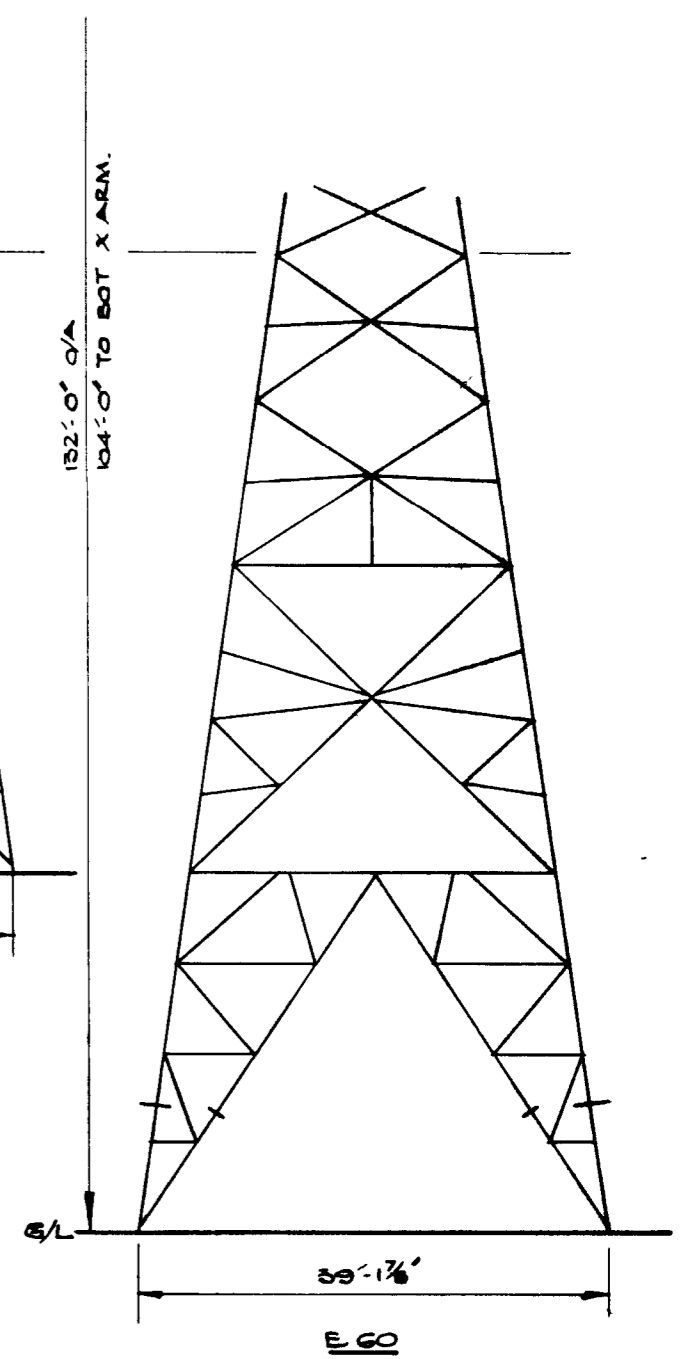
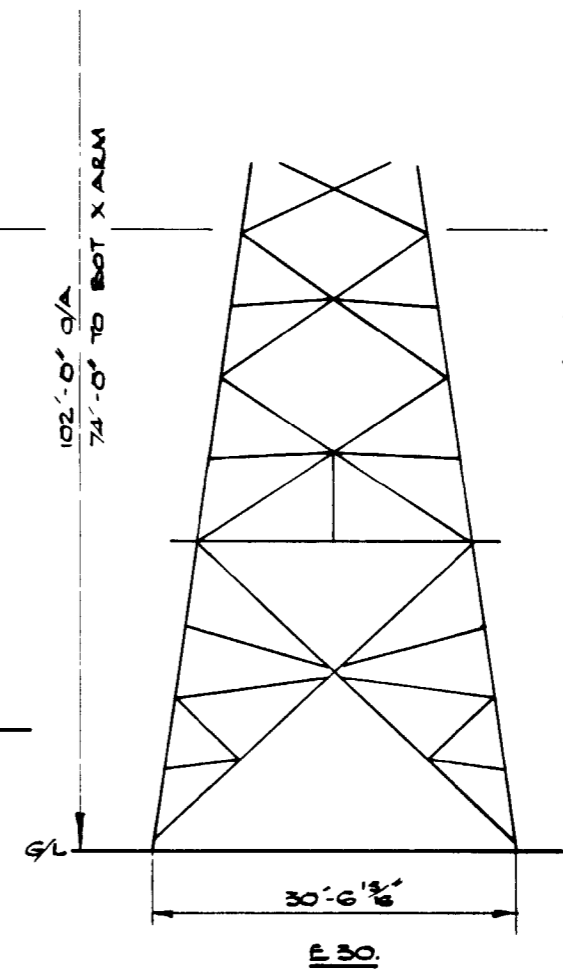
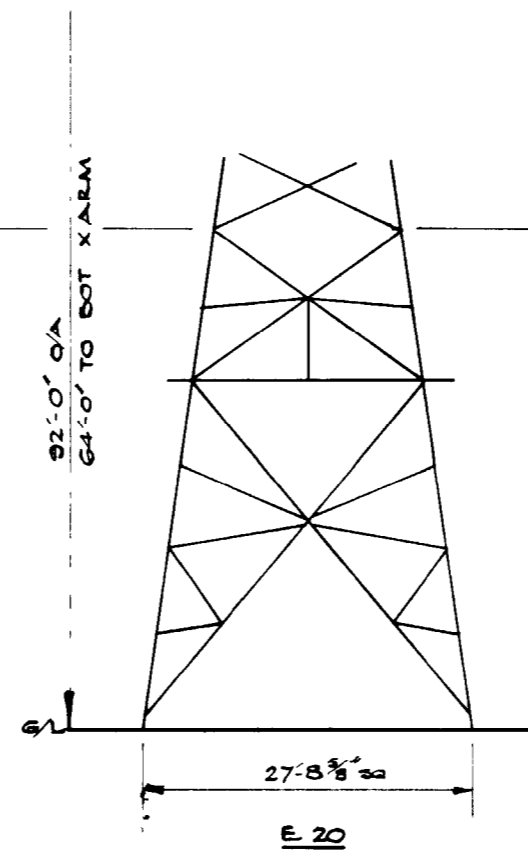
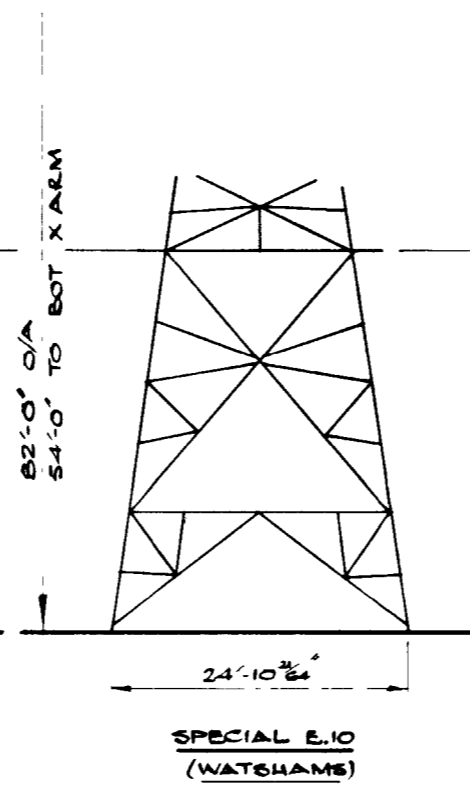
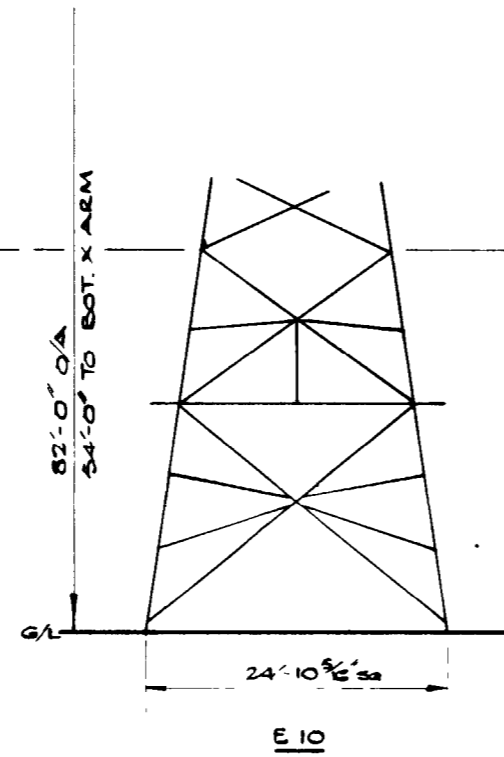
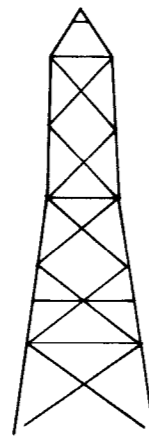
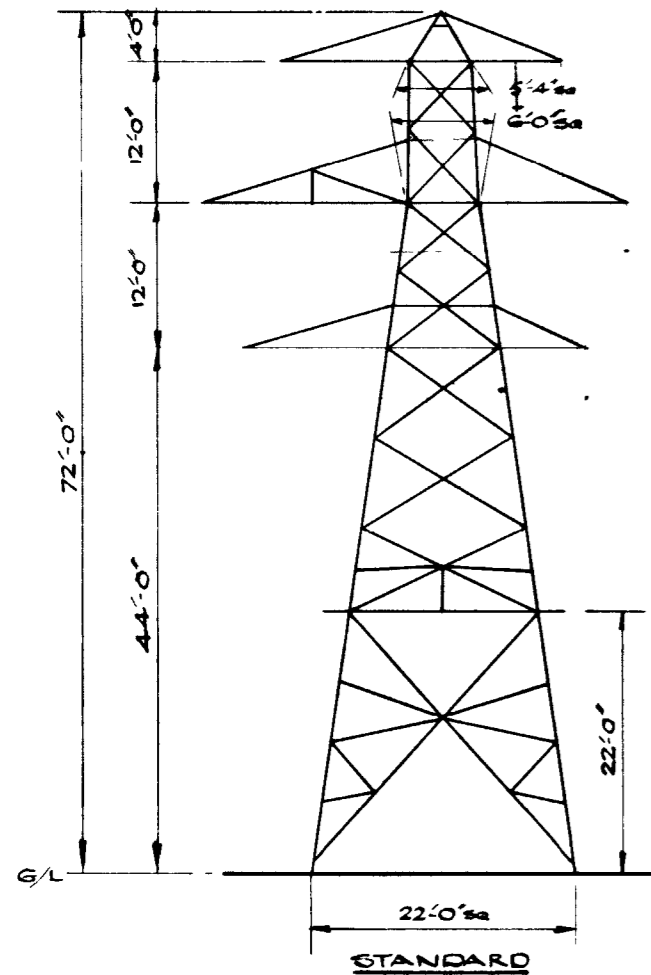

TOP

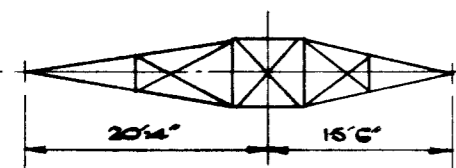

MIDDLE

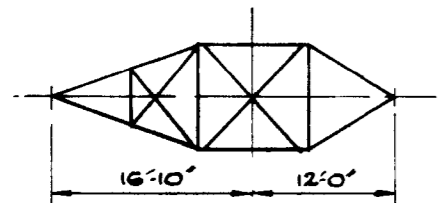

BOTTOM

PLANS OF CROSSARMS

REF DRGS:

STANDARD	35/1466
E 10	35/1467
SPECIAL E.10	55/1388
E 20	35/1468
E 30	35/1517
E 60	35/1500 35/1501

D.60° TOWER. (PIRELLI)

DESIGN TYPE: SEE P.L.I.A.

SCALE: 1/8" = 1 FT.

DRAWN	LWF	25-9-56
TRACED		
CHECKED		

DRG. NO. ED.51129

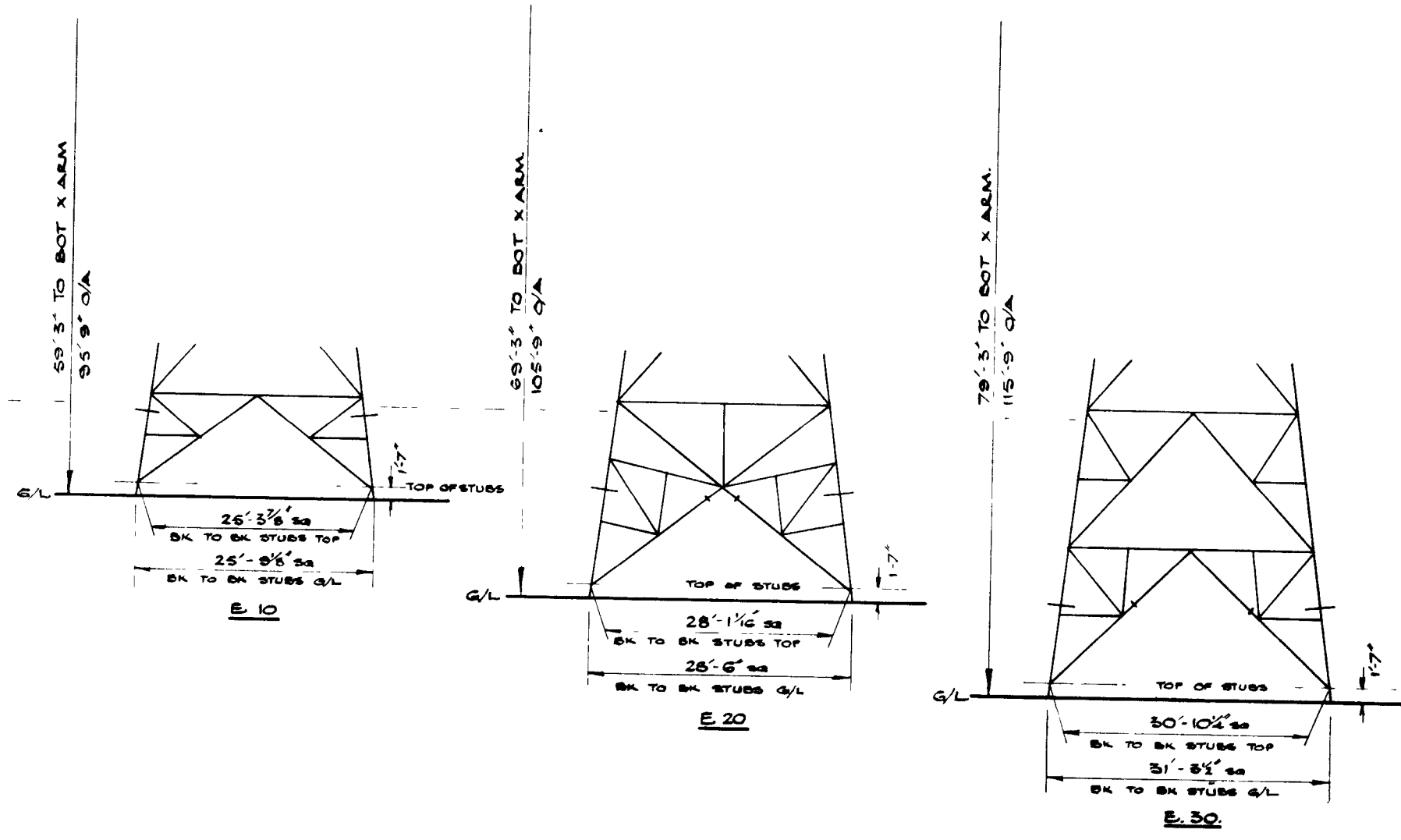
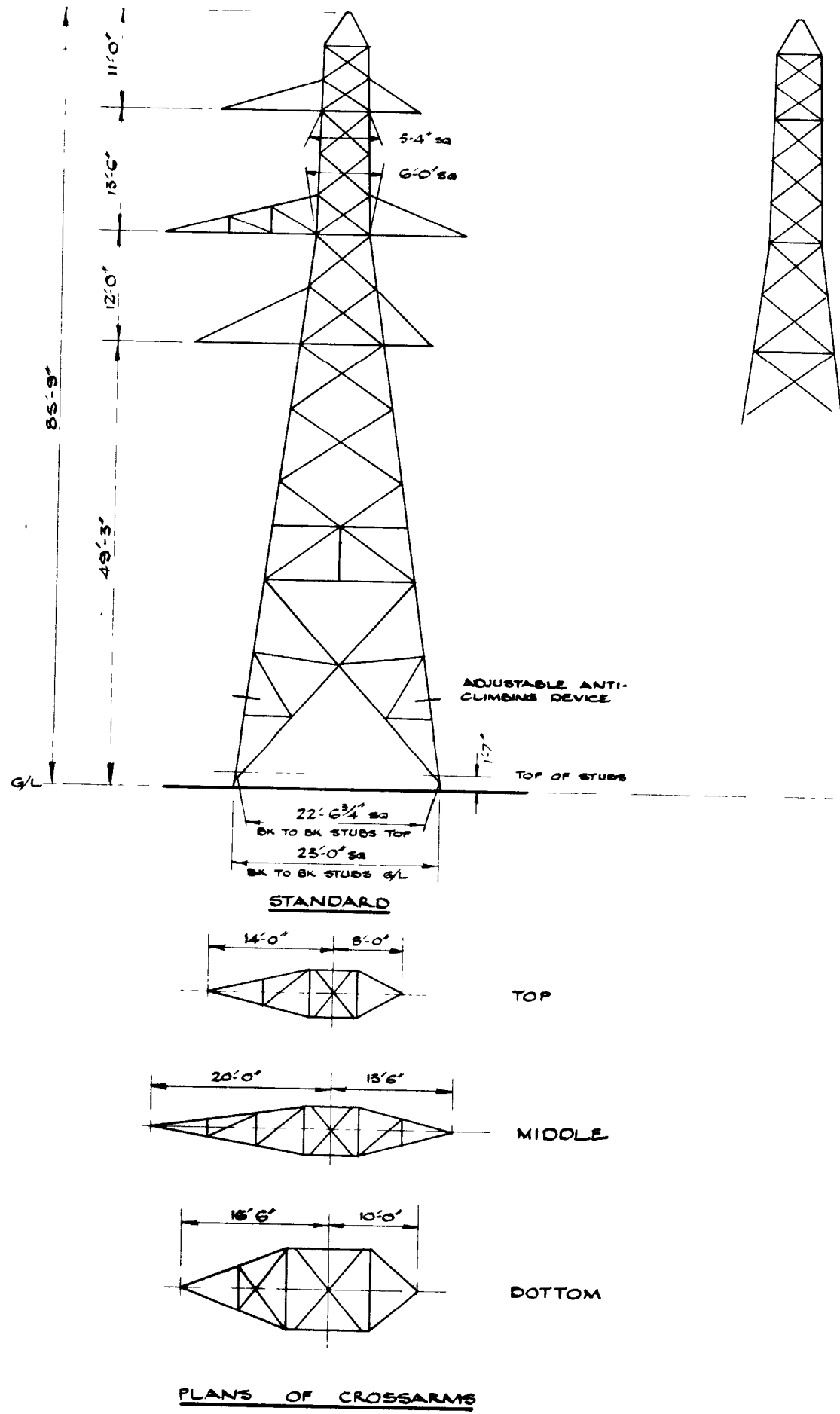

REF DRGS.	GEN. ARGT	ERECTION
STANDARD	34/818 34/791.	34/838.
E.10 E.30	34/859 35/1476	35/840
E.20	35/841 35/1024	35/842

DRAWN	LWF	15 9-24
TRACED		
CHECKED		

D.60° TOWER. (BLAW KNOX)
 DESIGN TYPE: C.E.P.L.4.
 SCALE: 1/8" TO 1 FT.

DRG. NO. **ED.51130.**

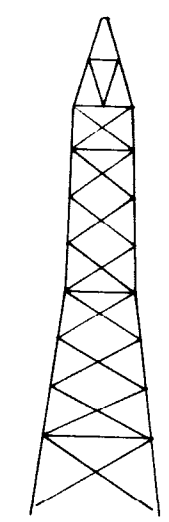
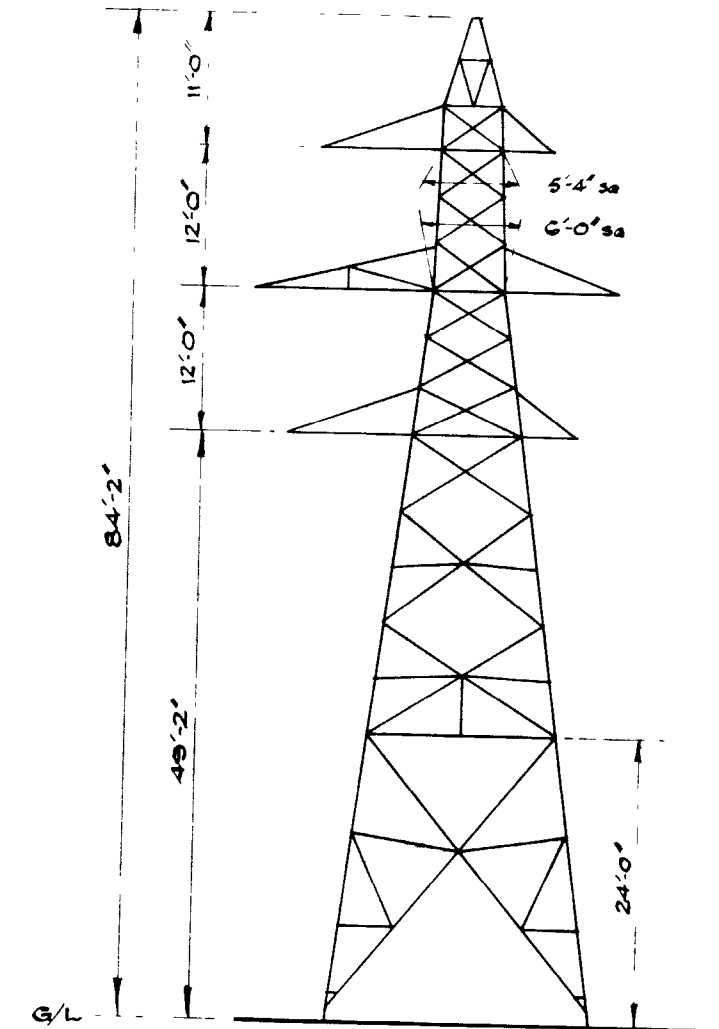

22'-0" sa
STANDARD

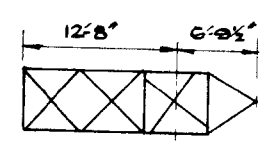

TOP

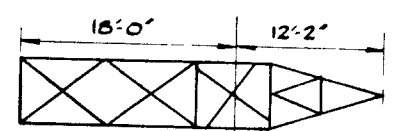

MIDDLE

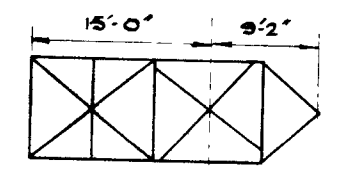

BOTTOM

PLANE OF CROSSARMS

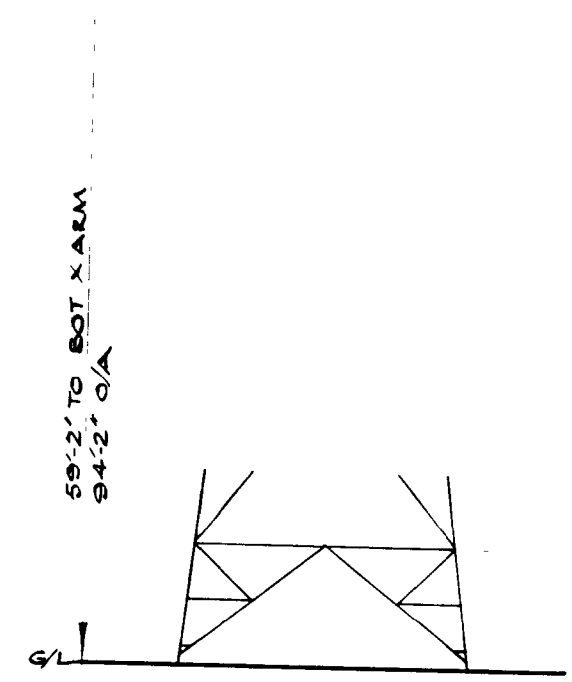

E.10

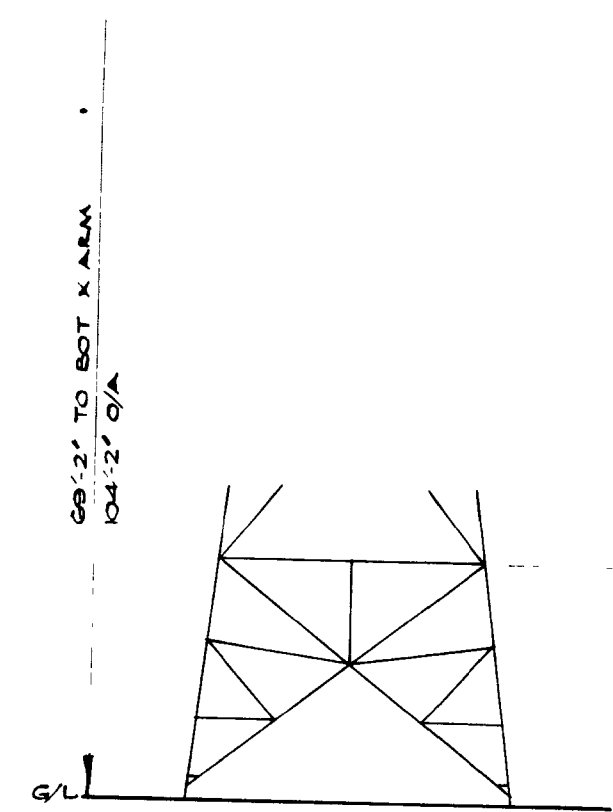

E.20

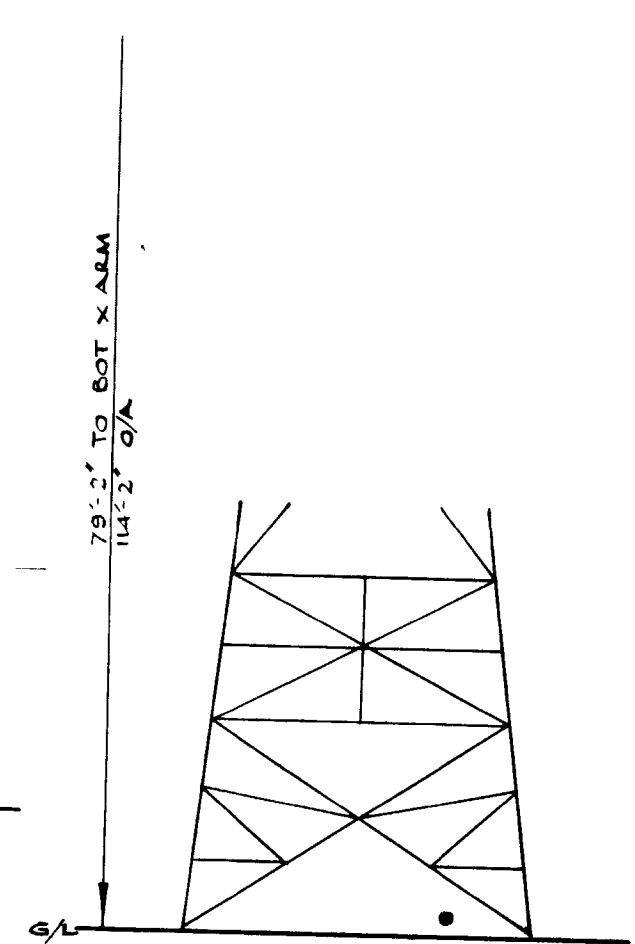

E.30

REF DRGS	
STANDARD	35/1669
E.10, E.20	35/1670
E.30	35/1671

DRAWN	L.W.F.	14.5.66
TRACED		
CHECKED		

D.60° TOWER.(WATSHAMS)
DESIGN TYPE: S.E.E. P.L.7.
SCALE: 1/16" TO 1 FT.

DRG. NO. ED.51131.

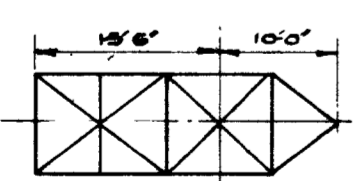
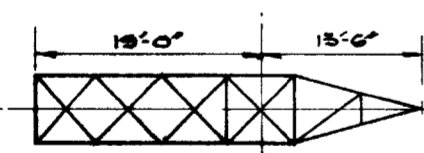
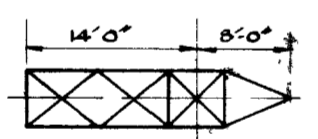
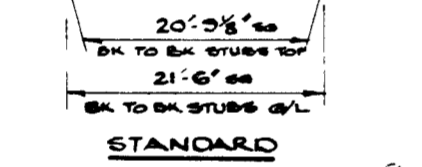
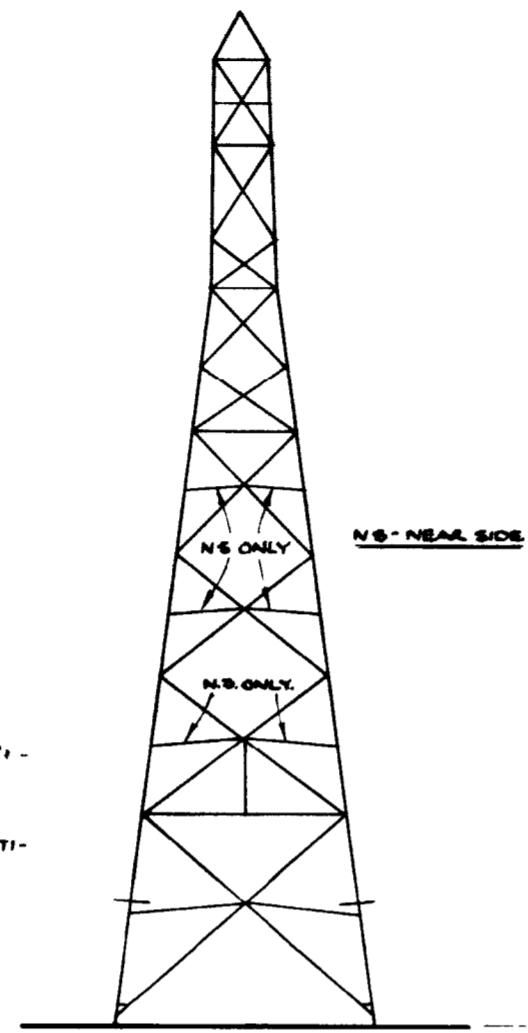
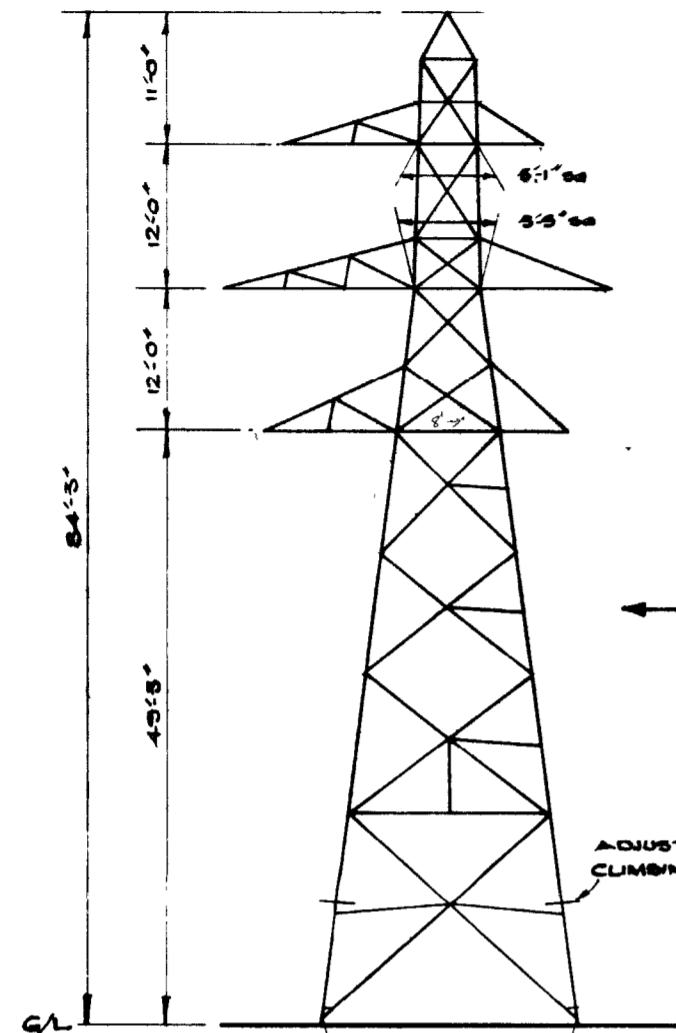

PLANS OF CROSSARMS.

8
7
5
0
2-6
TOP

MIDDLE

BOTTOM.

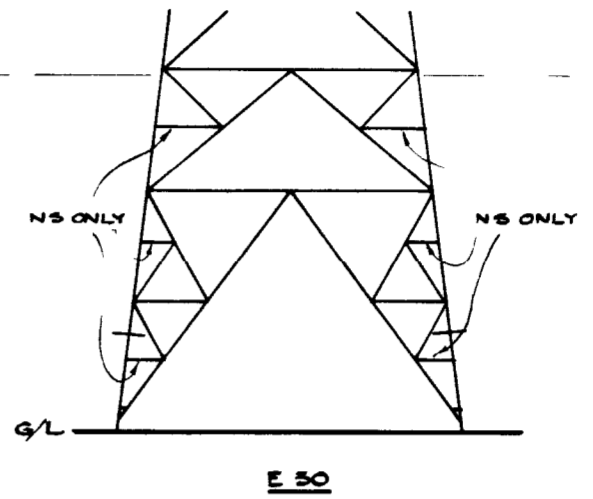
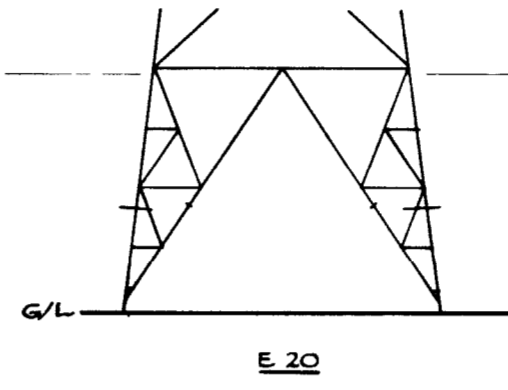
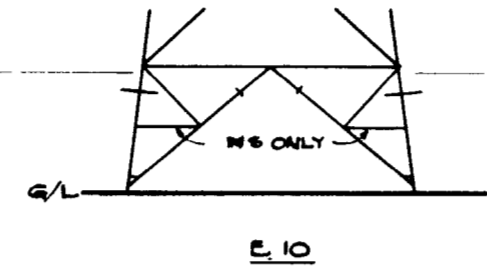

VIEWS OF EXTENSIONS ON ARROWS X

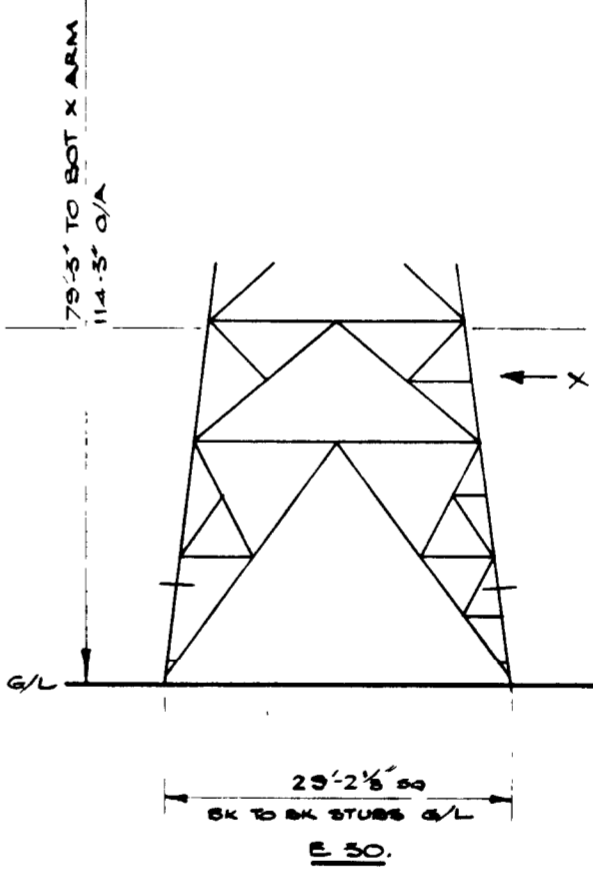
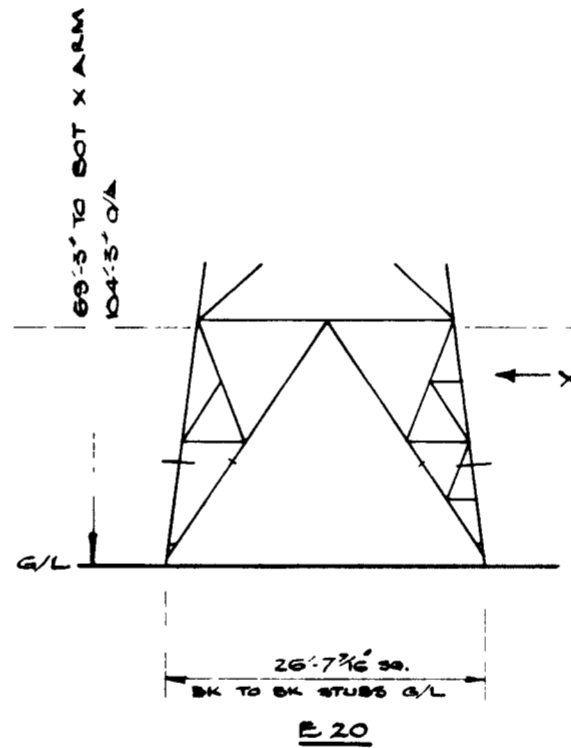
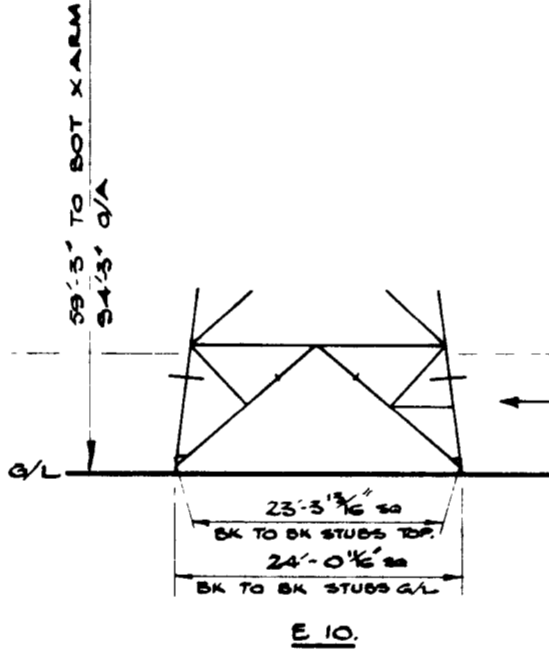

TRANSVERSE VIEWS.

REF ORGS	GEN ARRST	ERECTION
STANDARD	34/888	34/916
CROSSARMS	34/887	34/920
E 10	34/935	34/3572
E 20	34/937	
E 30	34/3593	

D.60° TOWER. (BLAW KNOX)
 DESIGN TYPE: SWE. P.L. 16.

SCALE: 1/4" = 1 FT

DRAWN	L.W.P.	15 9-56
TRACED		
CHECKED		

DRG. NO. **ED.51132.**

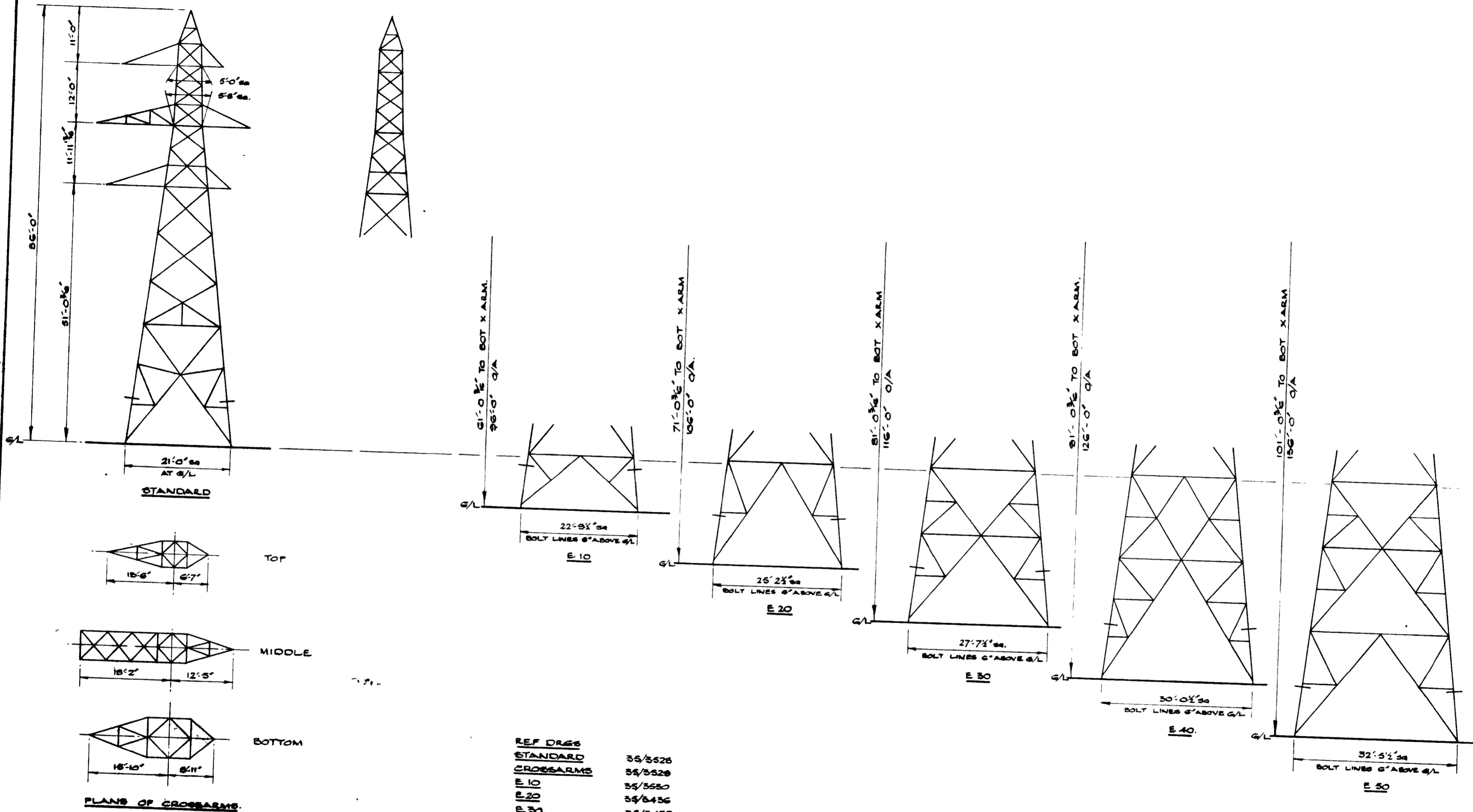

DRAWN	L.W.R.	25-9-66
TRACED		
CHECKED		

D. 60° TOWER.	
DESIGN TYPE: J.L.EVE.	
SCALE: 1/2" TO 1 FT	
DRG. NO.	ED. 51133.

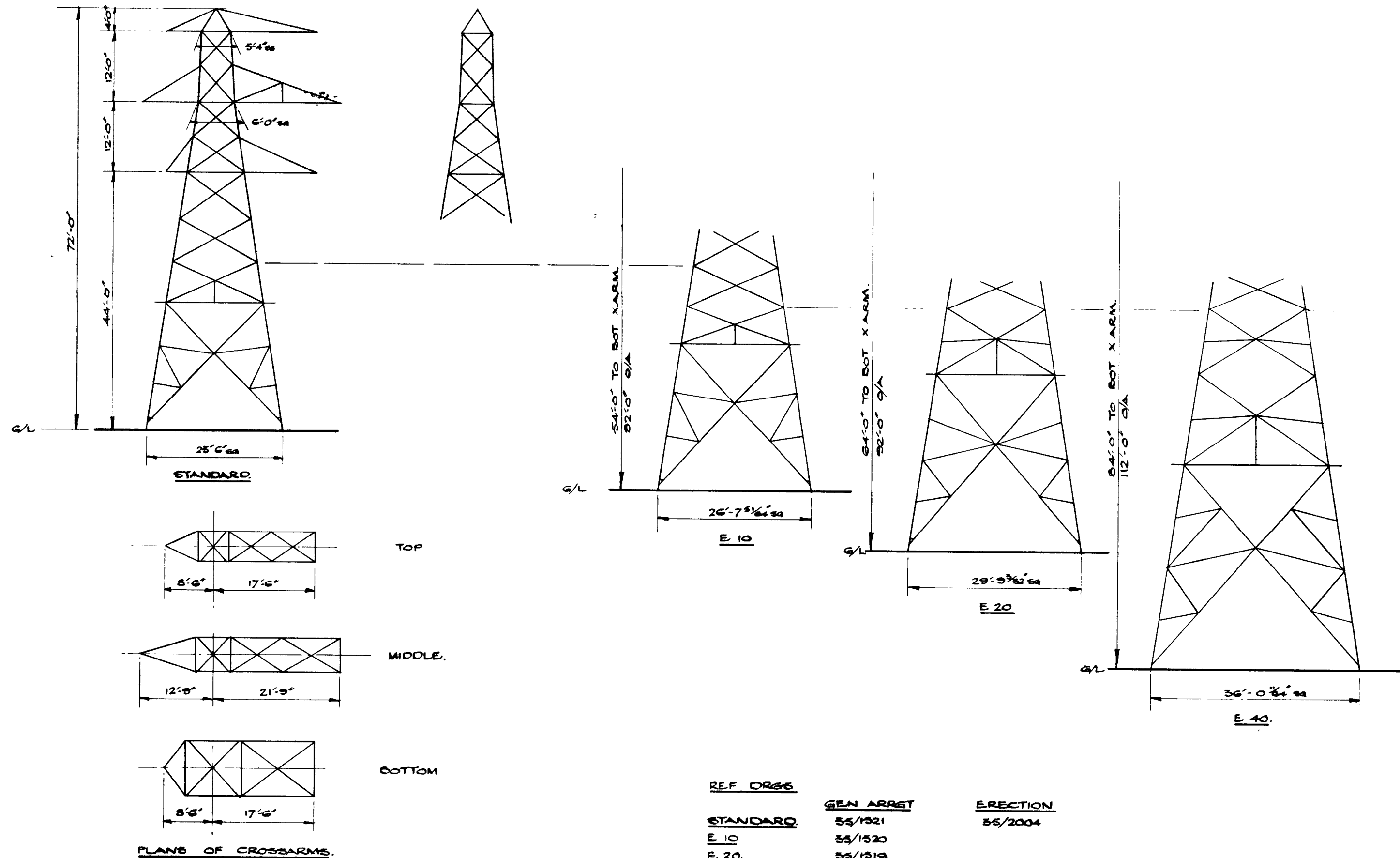

DRAWN	L.W.P.	27-11-56
TRACED		
CHECKED		

D.90° TOWER. (PIRELLI)
 DESIGN TYPE: S.E.E. P.L.I.A.
 SCALE: 1/16" TO 1 FT.

DRG. NO. ED. 51137.

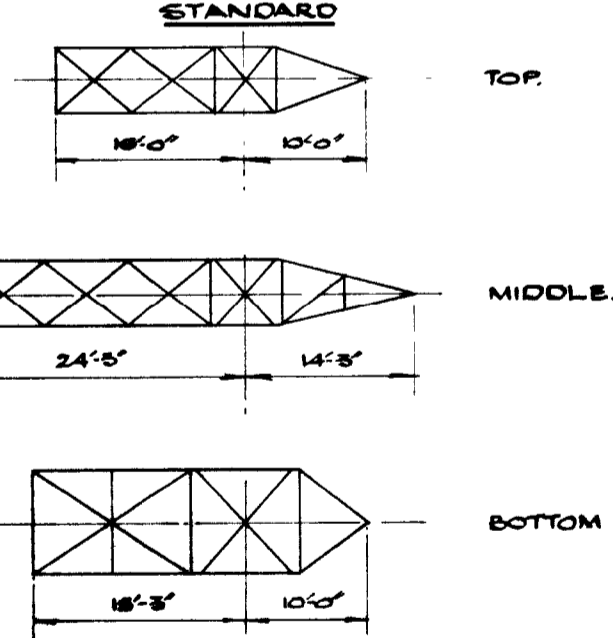
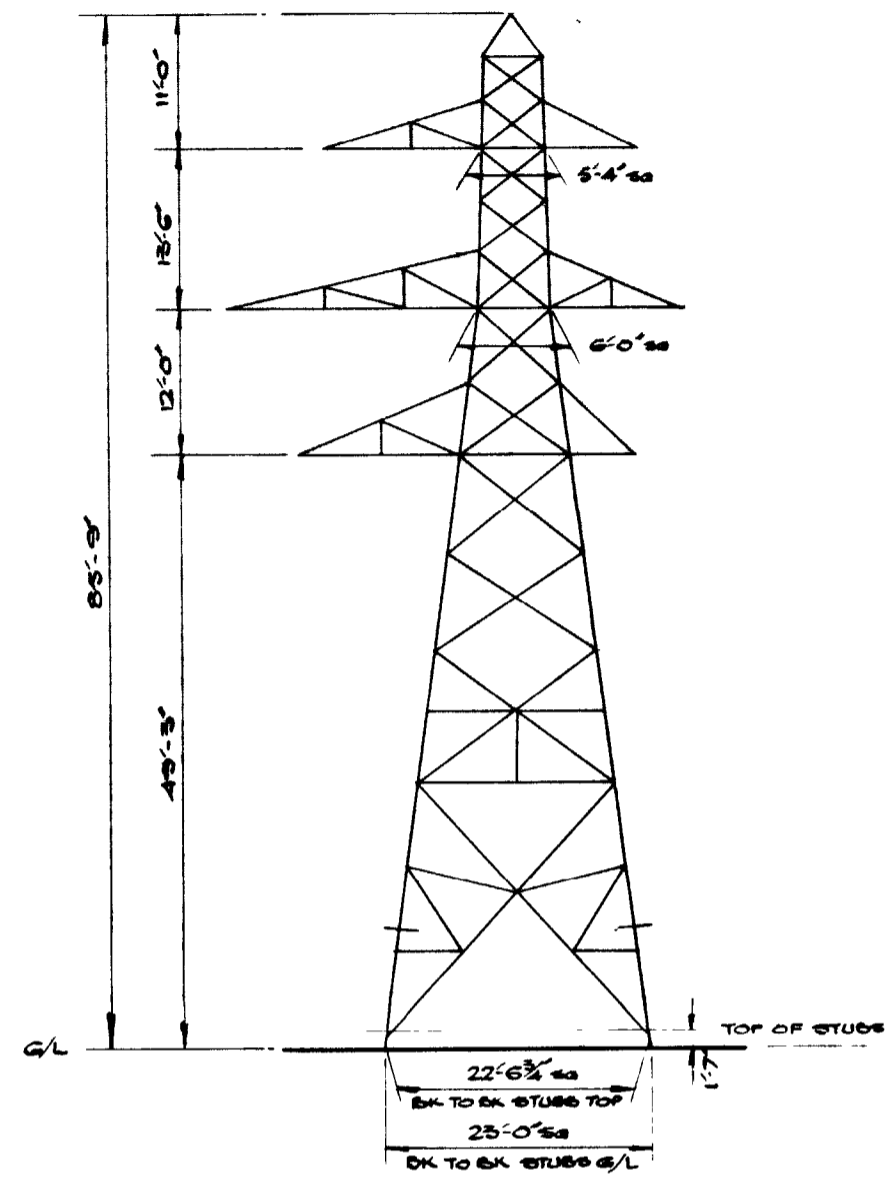

PLANS OF CROSSARMS.

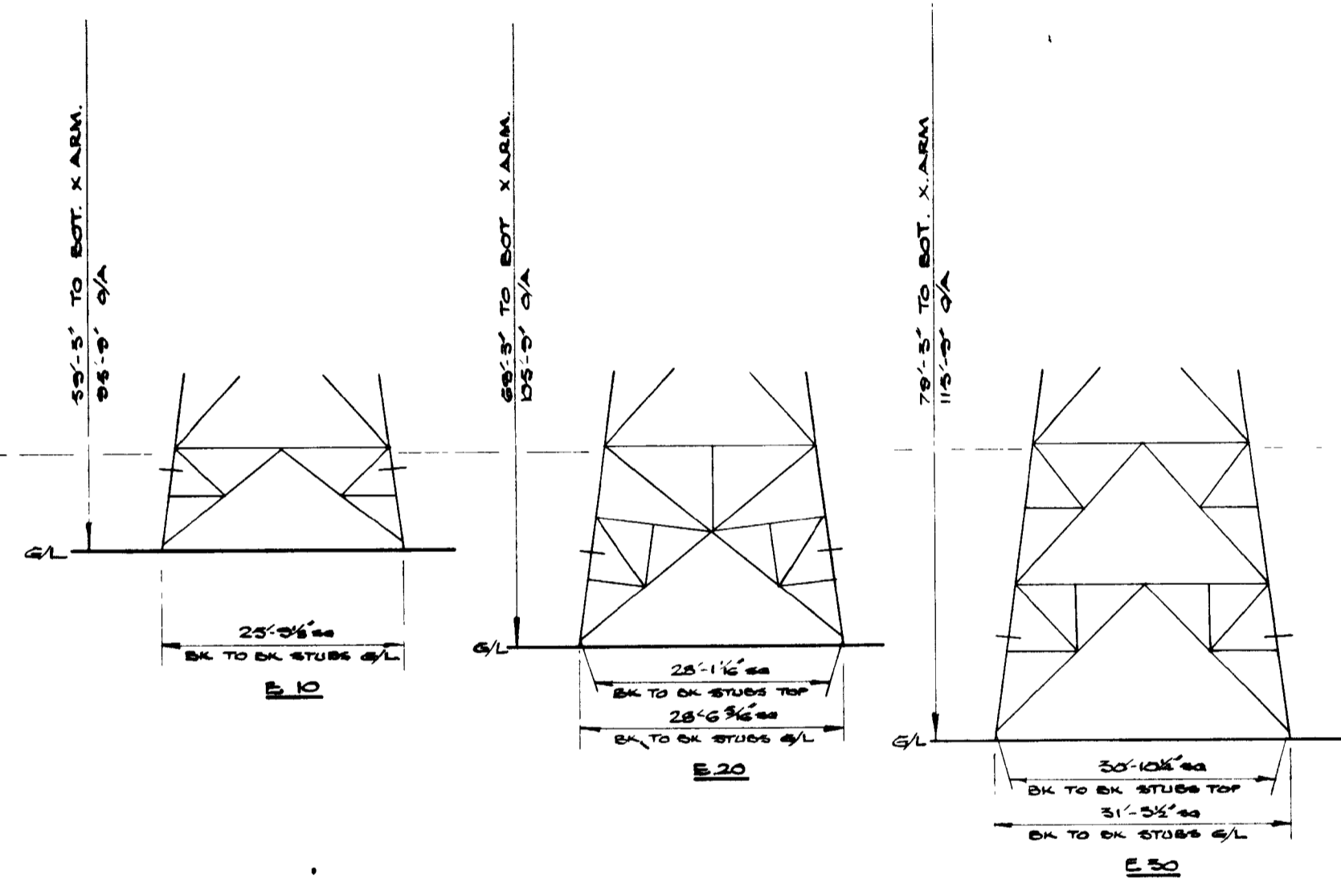

REF. DRGS.	GEN. ARRGT.	ERECTION.
STANDARD CROSSARMS		35/1175
E 10	35/843.	35/805. 35/870.
E 20		35/844. 35/1679
E 30	35/845	

D.90° TOWER. (BLAW KNOX)
 DESIGN TYPE: C.E. PL.4.
 SCALE: 3/16" TO 1 FT

DRAWN	L.W.F	26-11-42
TRACED		
CHECKED		

DRG. NO. ED. 51+38.

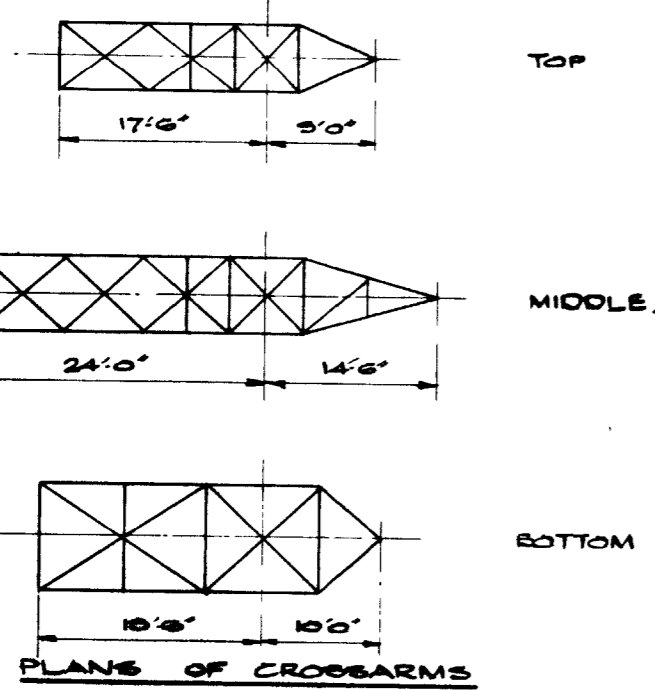
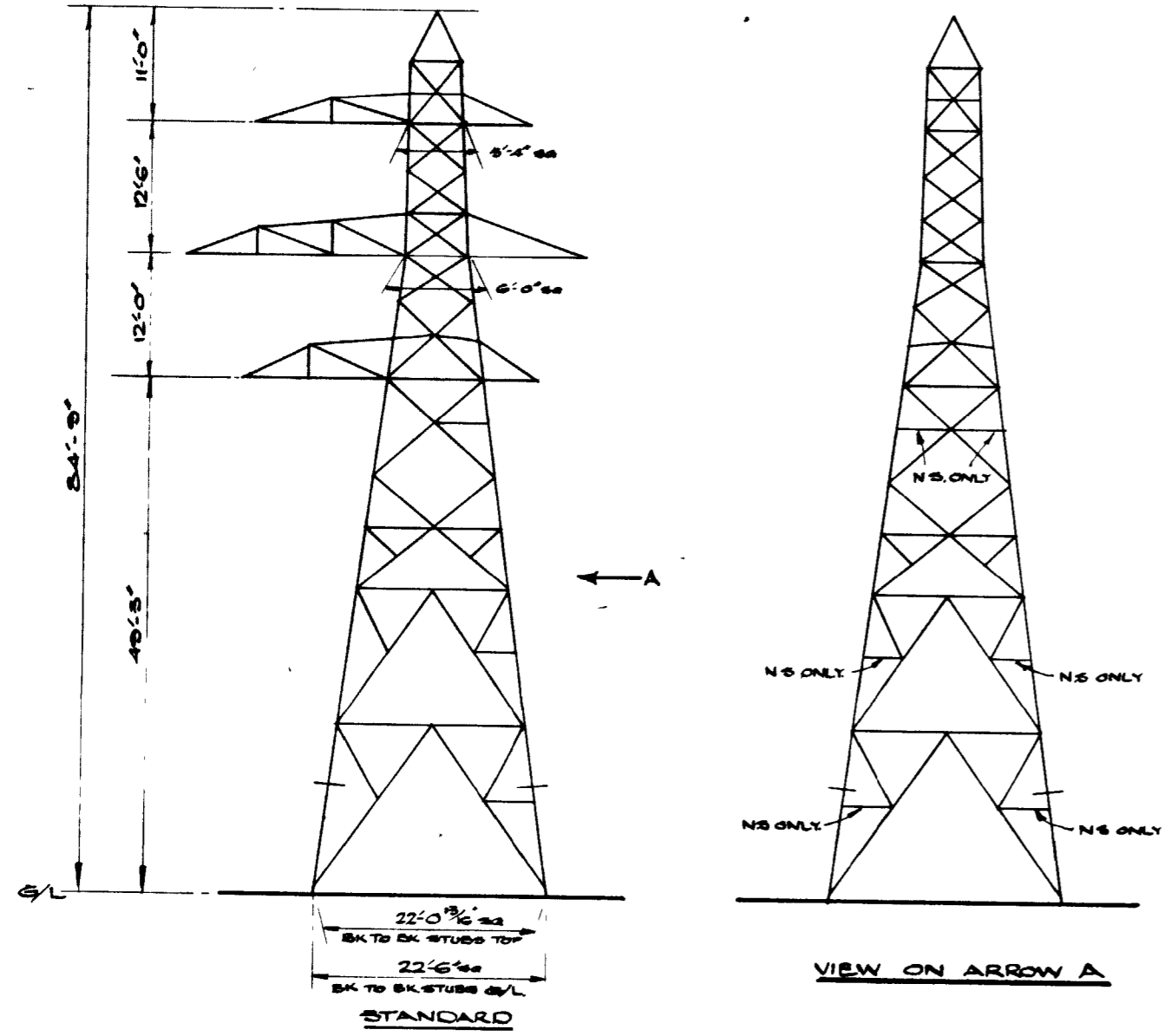

REF DRES	GEN. ARSST	ERECTION
STANDARD.	35/882	35/826
CROSSARMS	35/881	35/822

DRAWN	L.W.P.	27 11-24
TRACED		
CHECKED		

D.90° TOWER. (BLAW KNOX)
 DESIGN TYPE: S.W.E. P.L.16.
 SCALE: 1/2" TO 1 FT

DRG. NO.	ED.51139.
----------	------------------

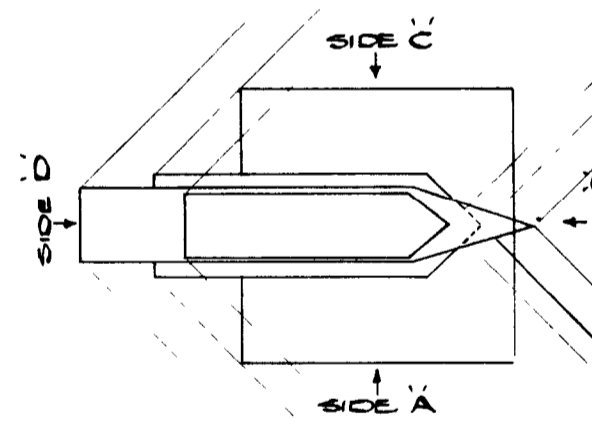
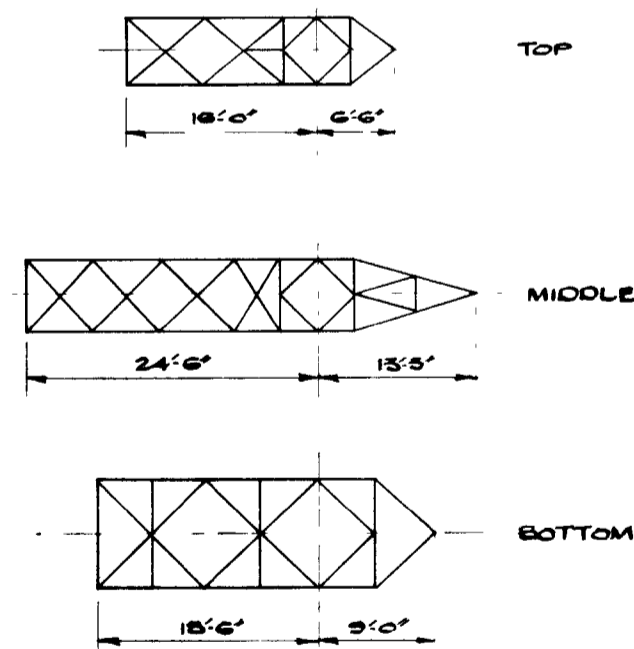
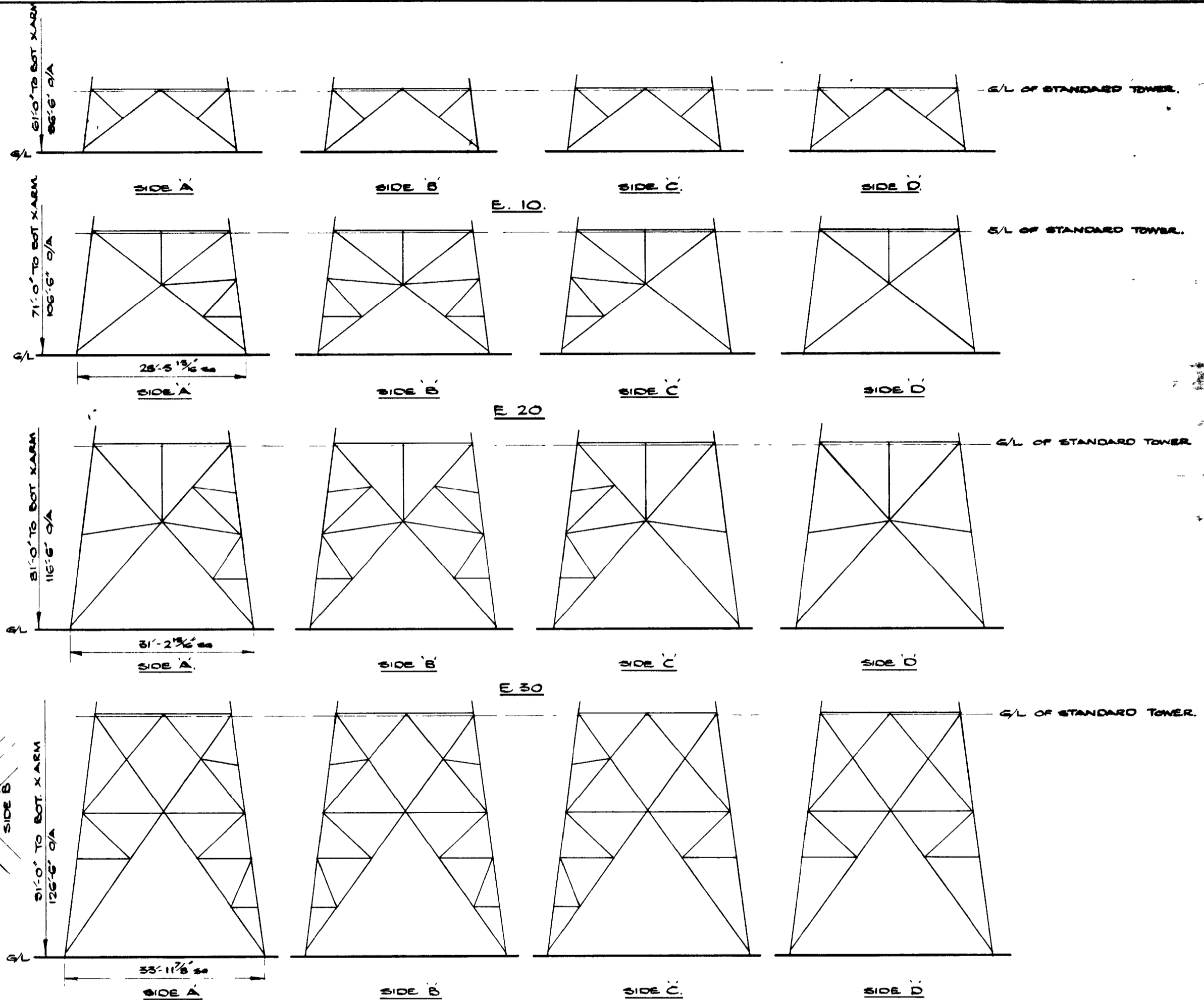
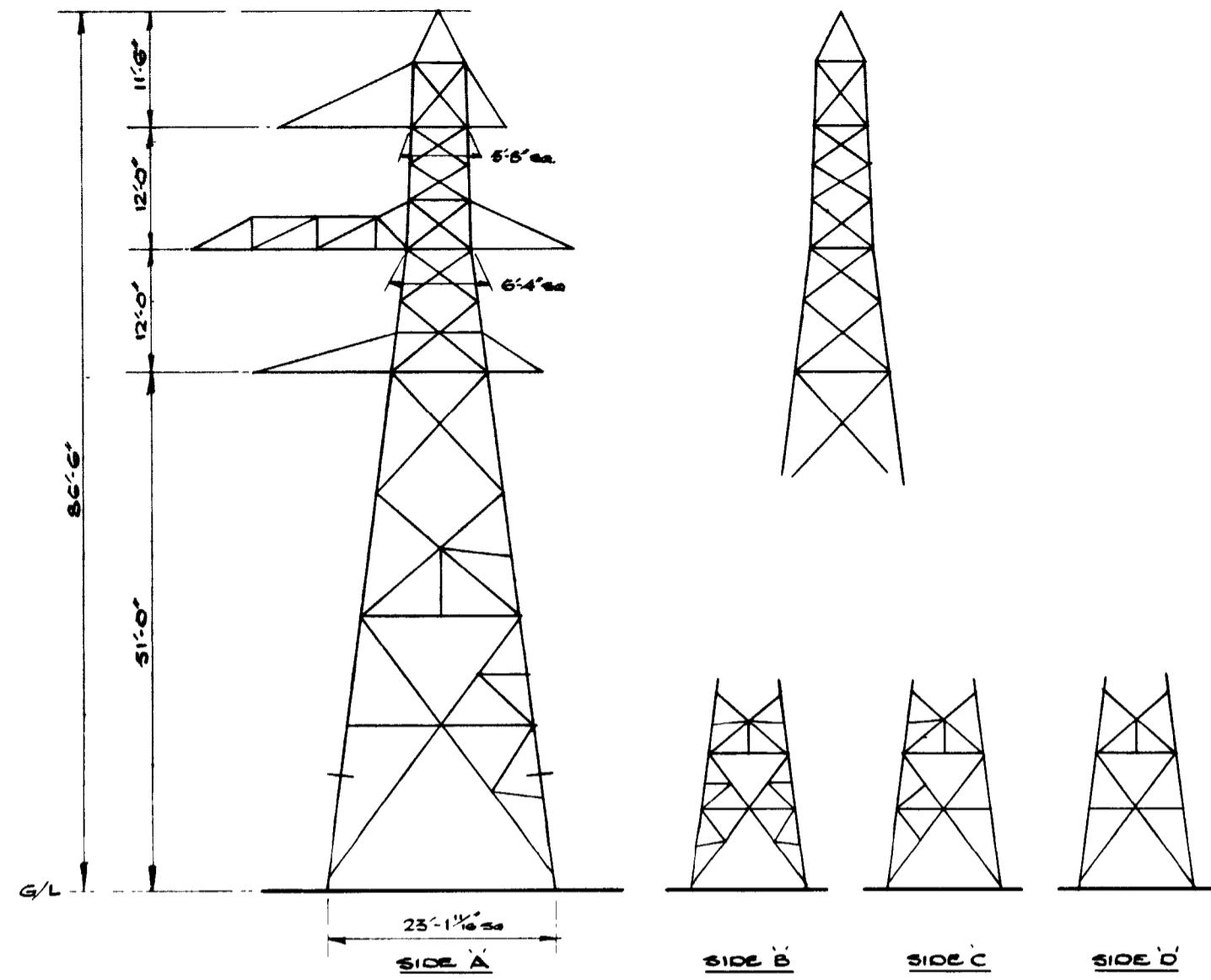

REF DRGS	GEN ARRGT
STANDARD	35/3193
CROSSARMS	35/3197
E 10	
E 20	35/3256
E 30	35/3256
E 40	35/3257
LINE DIAGRAMS	35/3259

DRAWN	LWF	25-11-22
TRACED		
CHECKED		

D.90° TOWER.
 DESIGN TYPE: J.L.EVE.
 SCALE: 1/16" TO 1 FT

DRG. NO. **ED.51140.**

D.T.

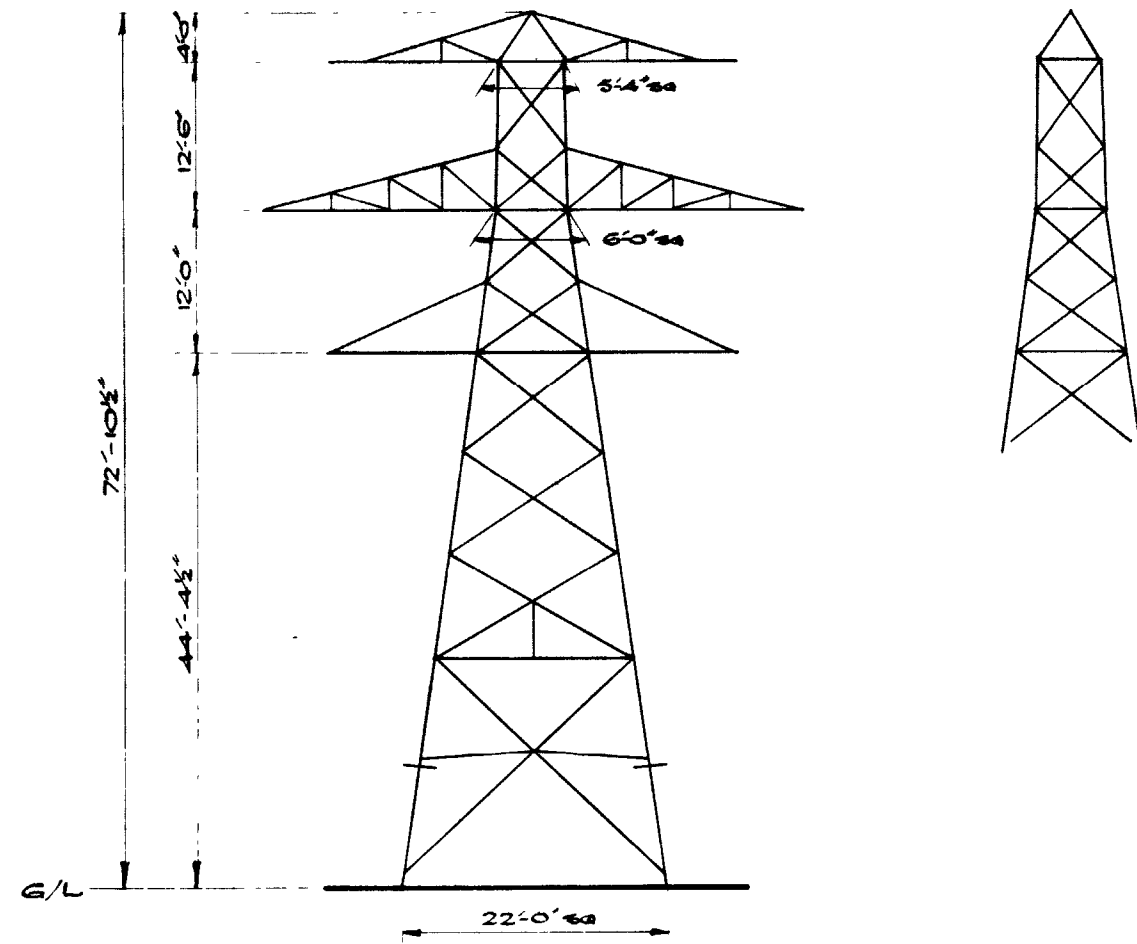

D.T. 90° (SPECIAL)

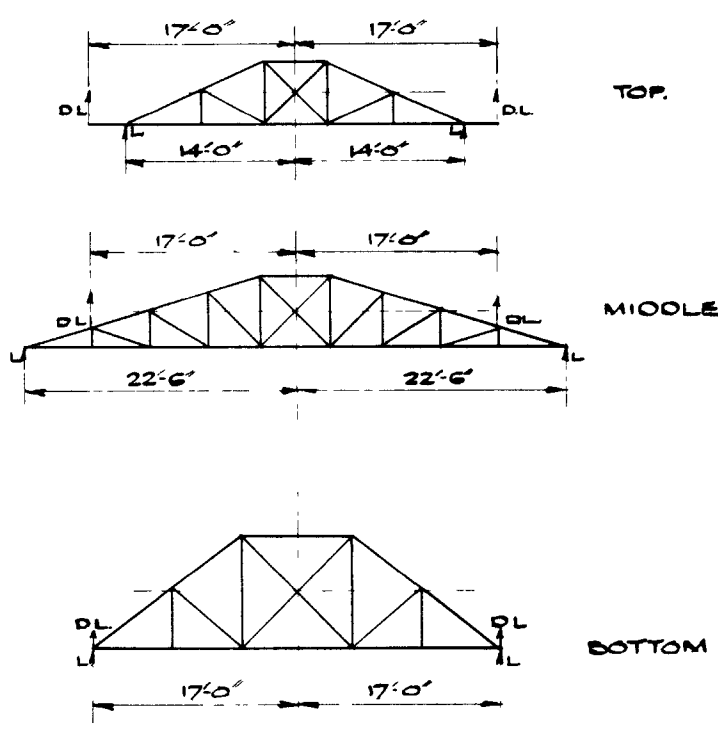
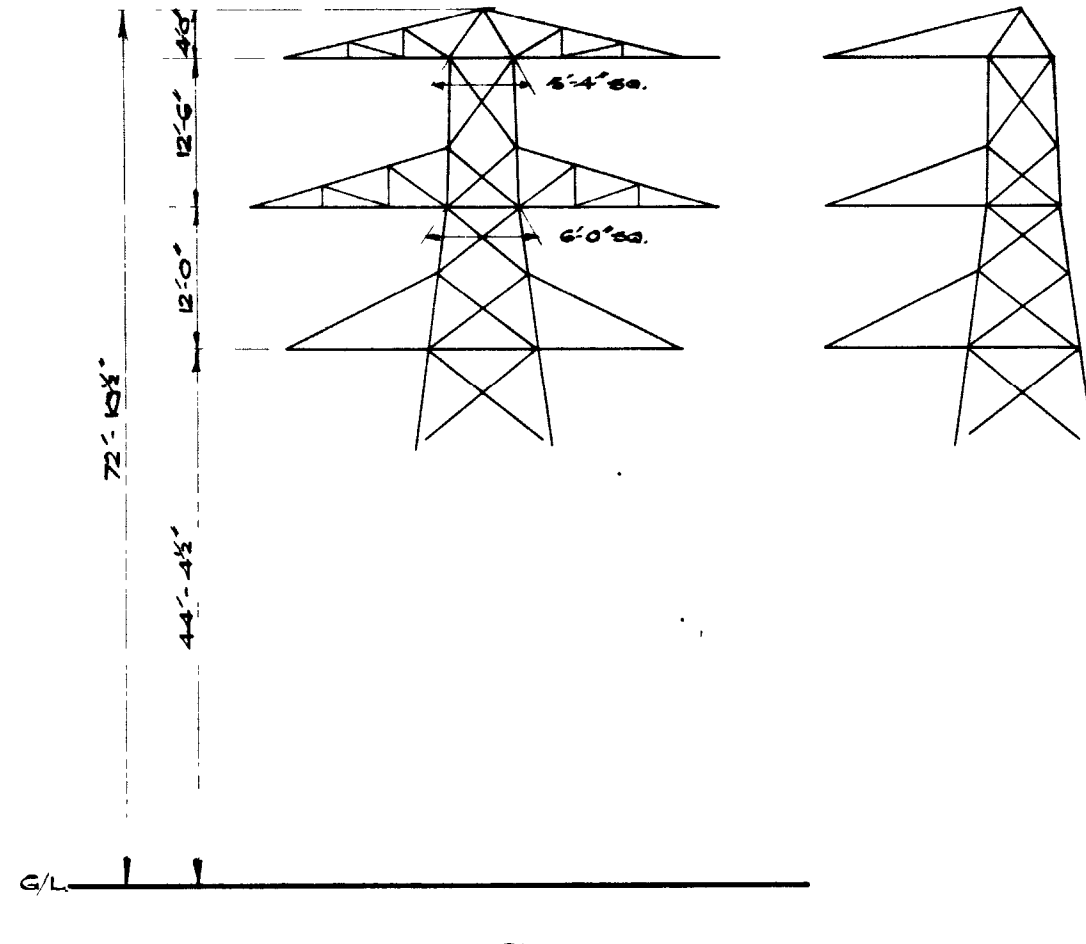

PLANS OF CROSSARMS.

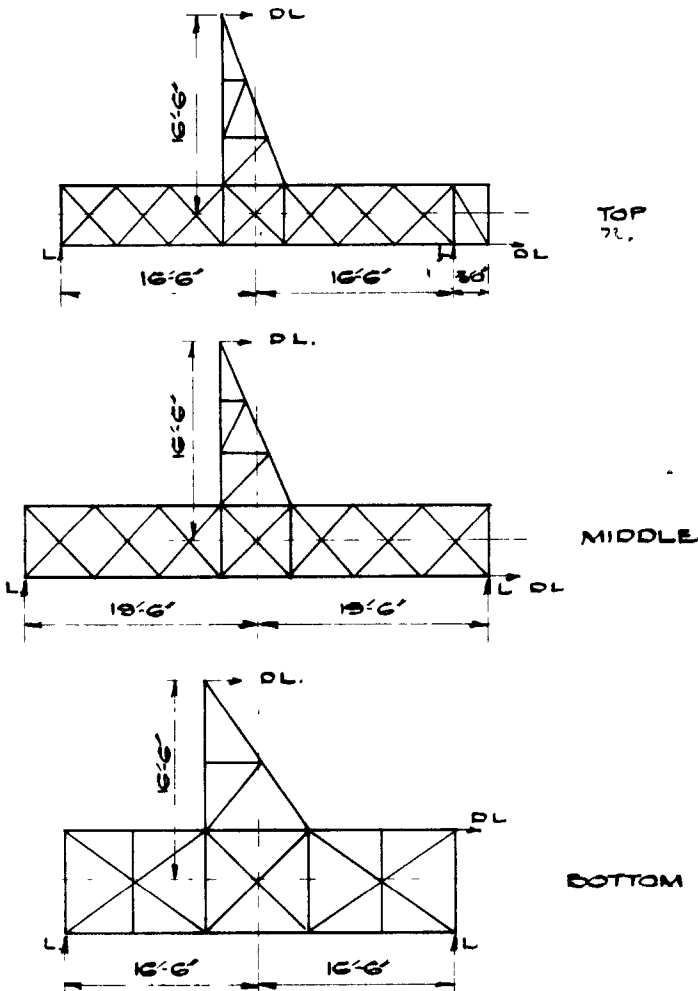

PLANS OF CROSSARMS.

DL - DOWNLEADS
L - LINE ENTRIES.

REF DRGS
D.T. 35/1346
D.T. 90° 35/1348

D.T. & D.T. 90° TOWER (MILLIKEN)
DESIGN TYPE: E.E. P.L.I.
SCALE: 1/8" TO 1 FT.

DRAWN	L.W.F	12-2-44
TRACED		
CHECKED		

DRG. NO. **ED. 51143.**

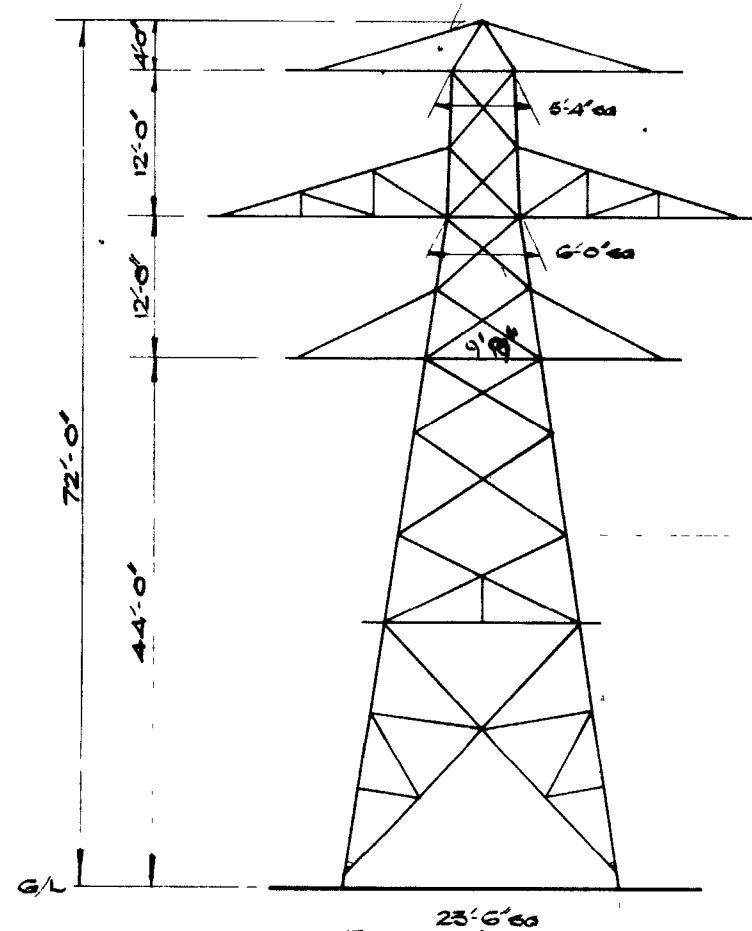

STANDARD

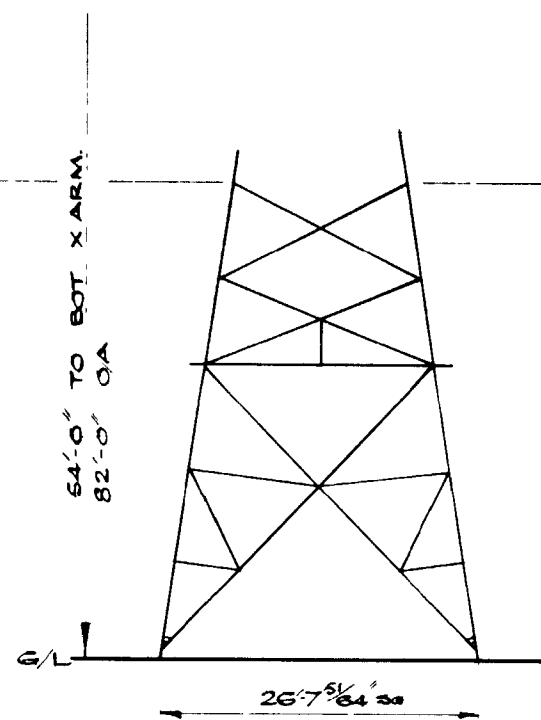
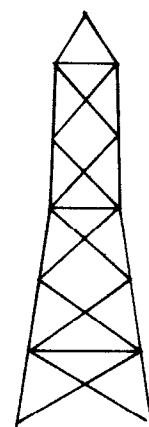

E 10

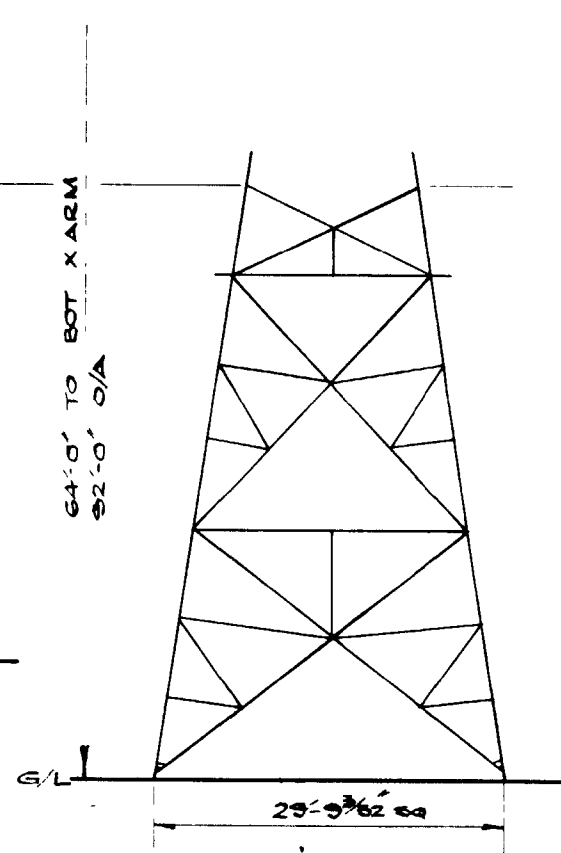

+20

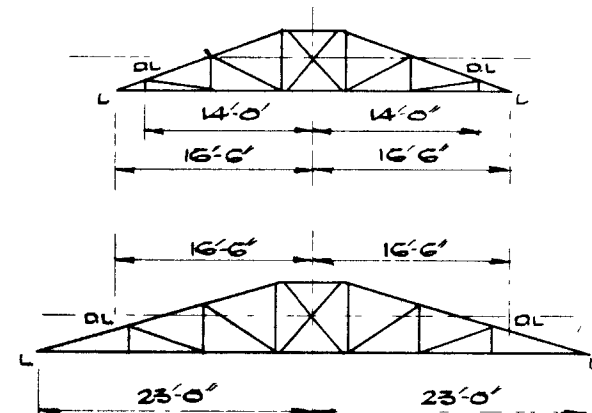

TOP

MIDDLE

BOTTOM

DL - DOWNLEAD POS'NS
L - LINE POS'NS

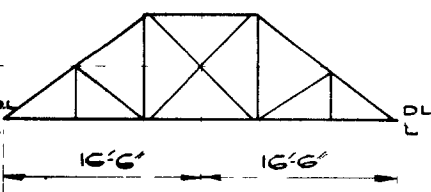

PLANS OF CROSSARMS

REF DRGS

STANDARD

E 10

+ 20

DT

35/1450

35/1502

35/2005

DT 45°

35/1531

35/1502

35/3549 (E)

DT. & DT. 45° TOWER (PIRELLI)

DESIGN TYPE: S.E.E. P.L.I.A.

SCALE: 1/16" TO 1 FT

DRG. NO. ED.51144.

DRAWN	L.W.F.	12/12/66
TRACED		
CHECKED		

CENTRAL ELECTRICITY AUTHORITY

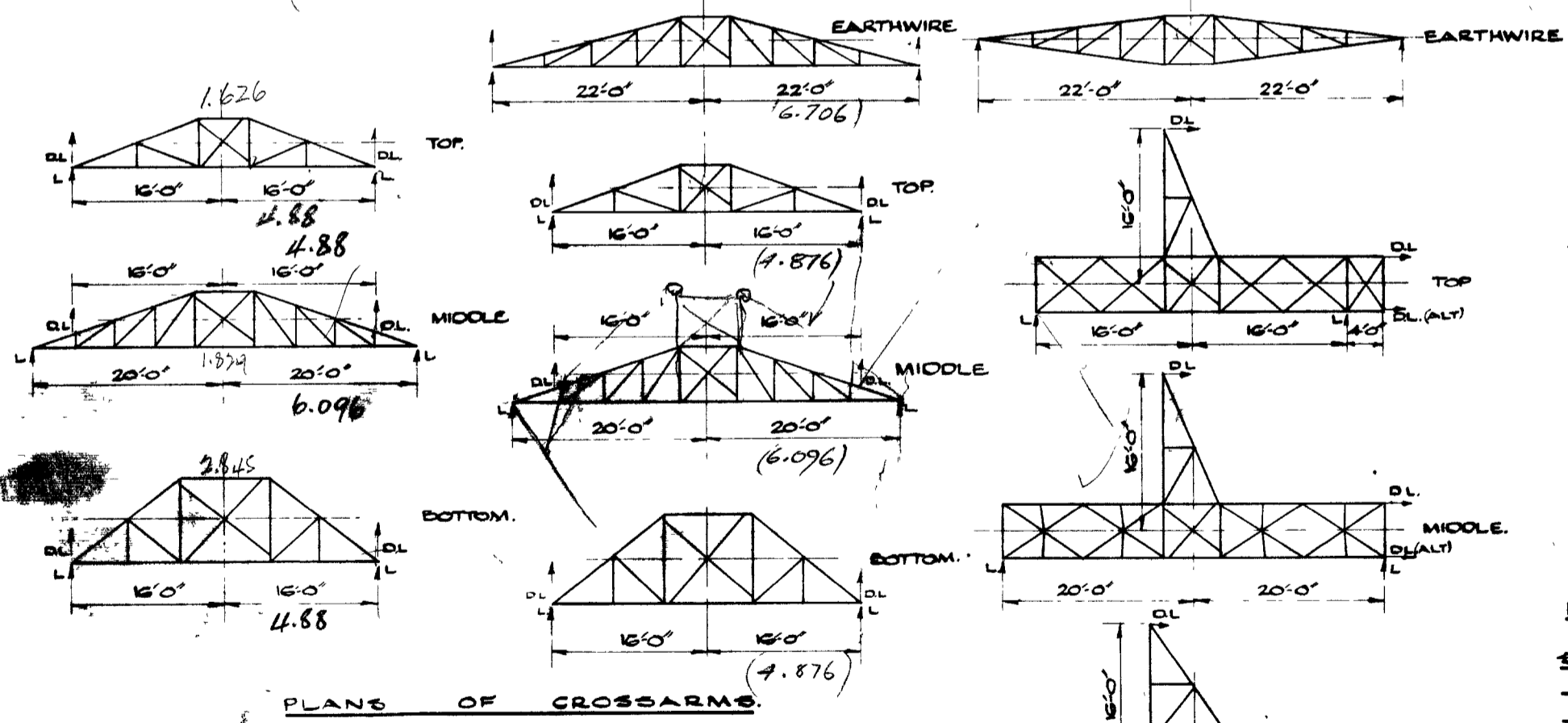
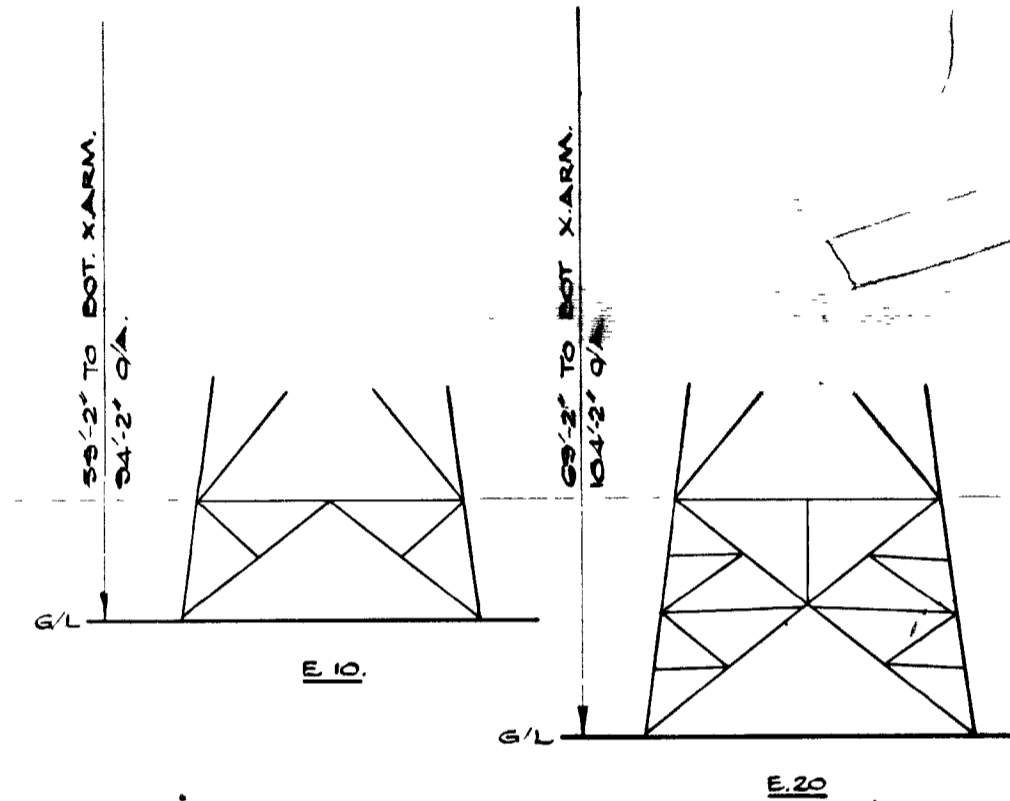
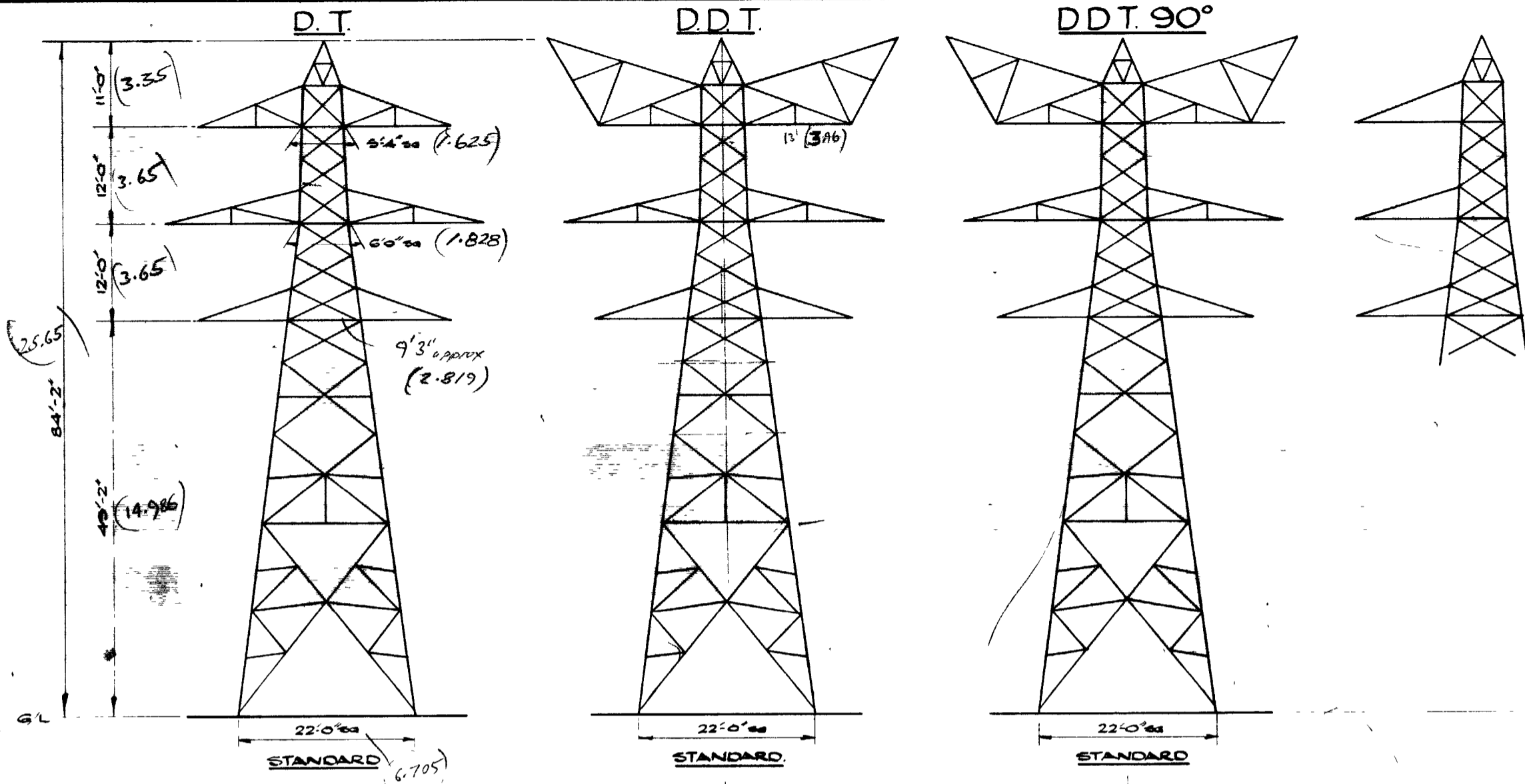

EXTENSIONS TO D.D.T. & D.D.T. 90° TOWERS.

REF DRGS.	GEN. ARRST.
STANDARD DT	33/1673
" DDT.	33/1648
" DDT. 90°	33/1672
E.10. E.20.	33/1647

DRAWN	LWF	15252
TRACED		
CHECKED		

L - LINE ENTRIES
 DL - DOWNLEAD POS'NS.

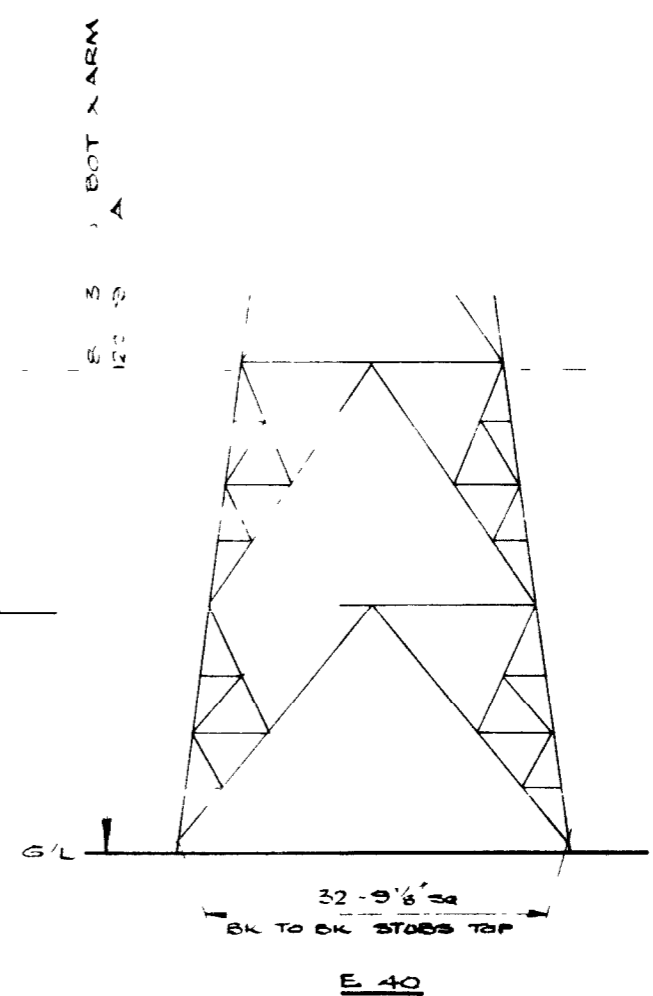
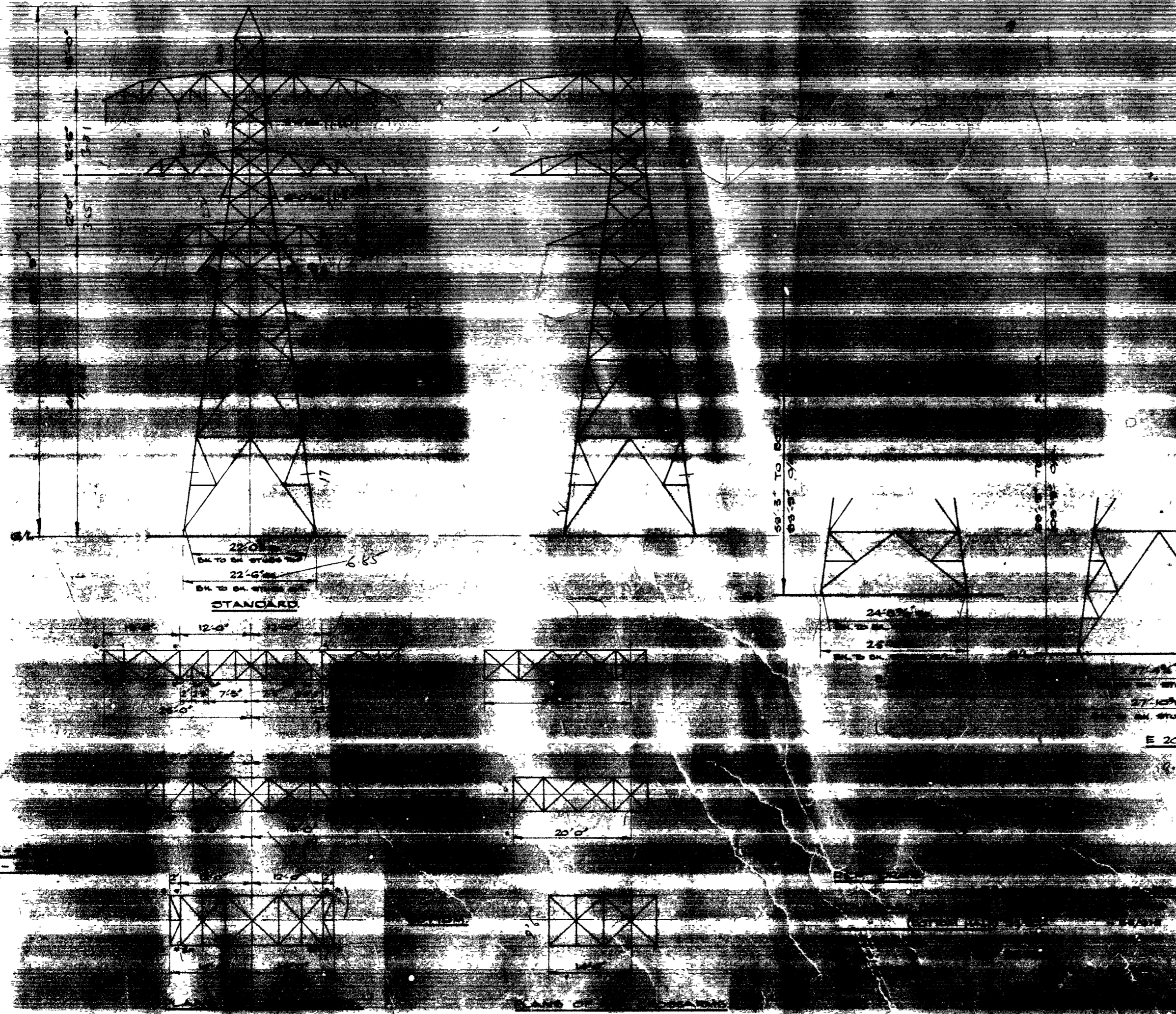

DRAWN	L.M.P.	7-12-30
TRACED		
CHECKED		

D.T. TOWER. (BLAW. KNOX)
 DESIGN TYPE SWE. PL16
 SCALE: 1/4" = 1'-0"

DRG. NO. ED.51149

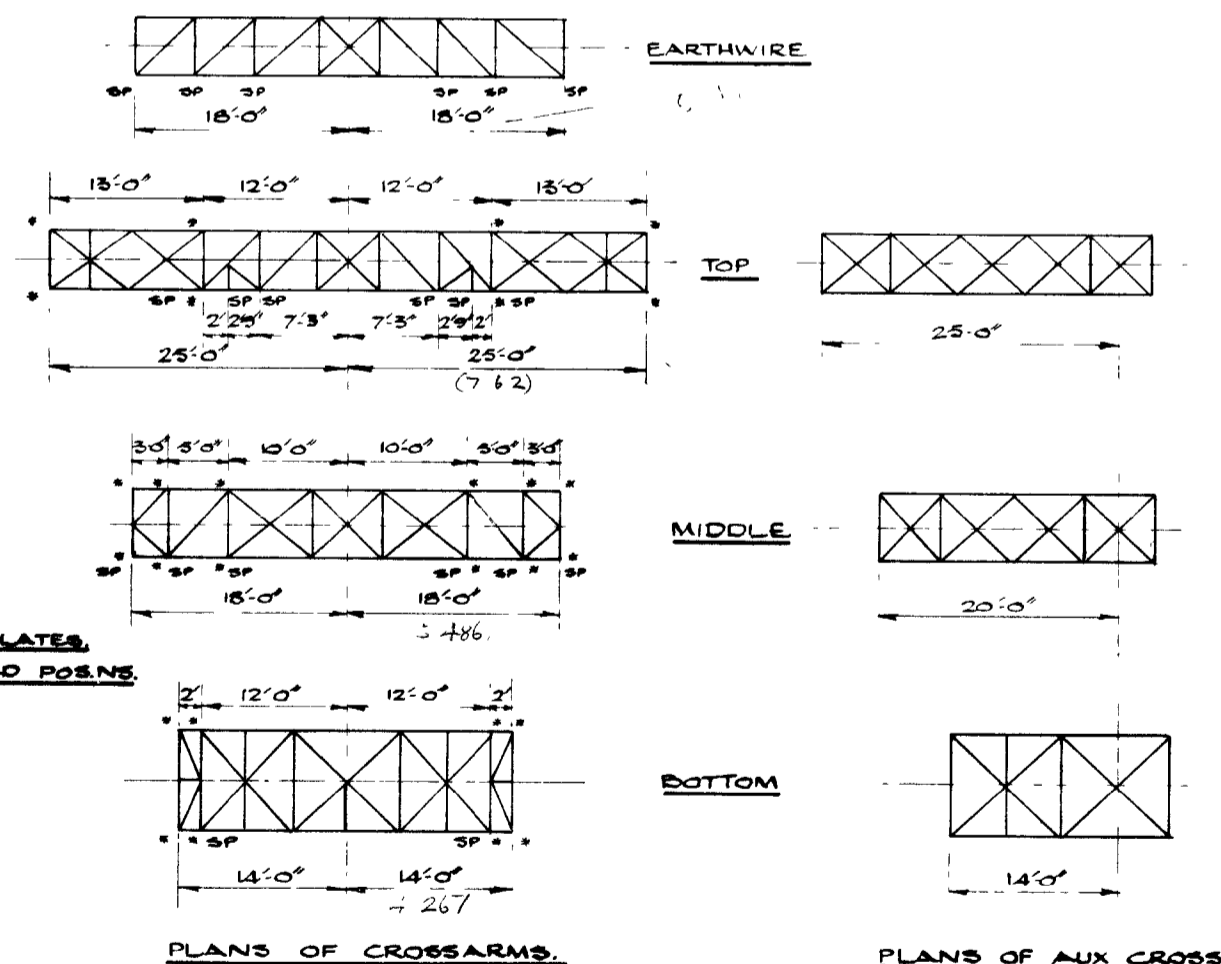
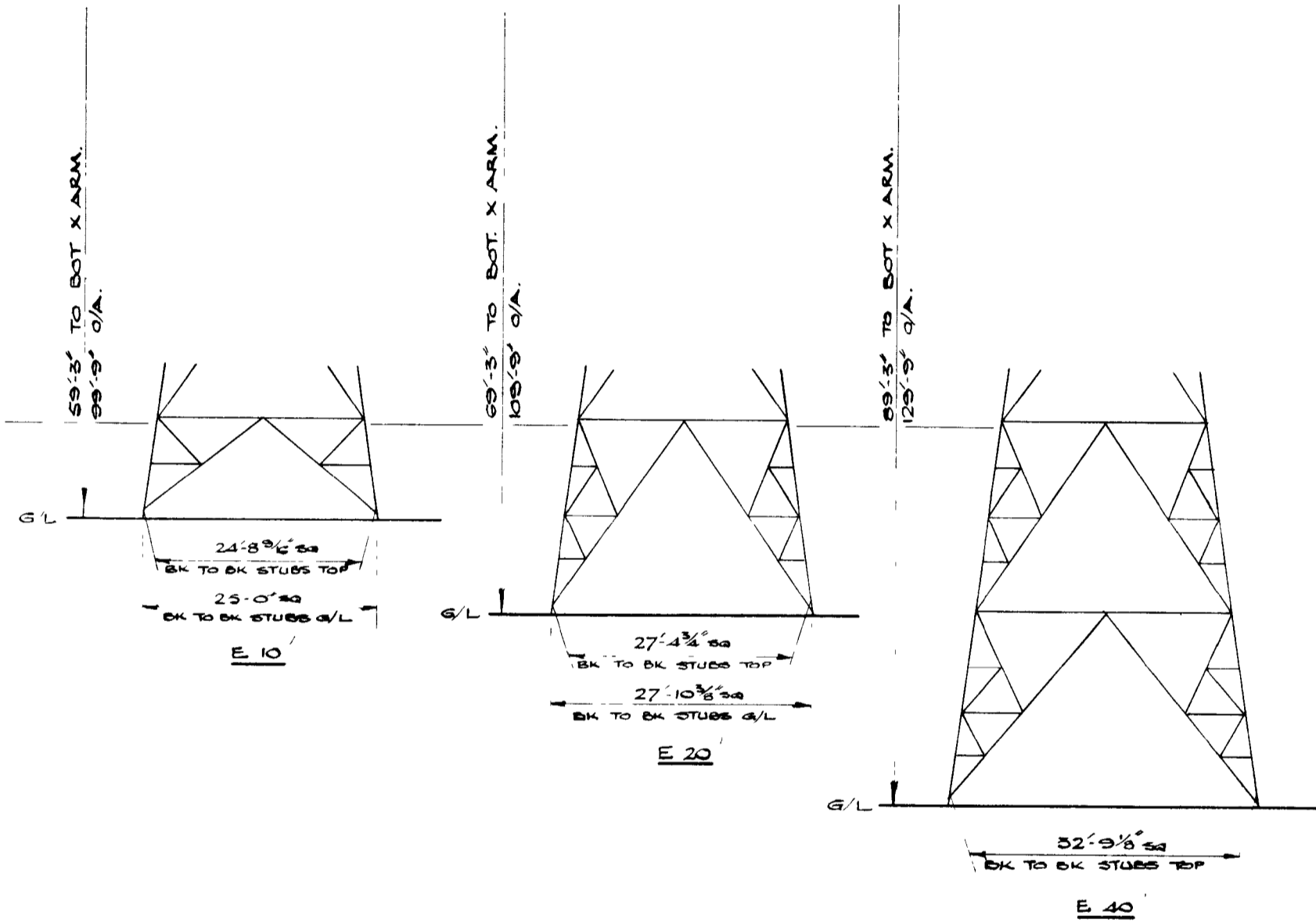
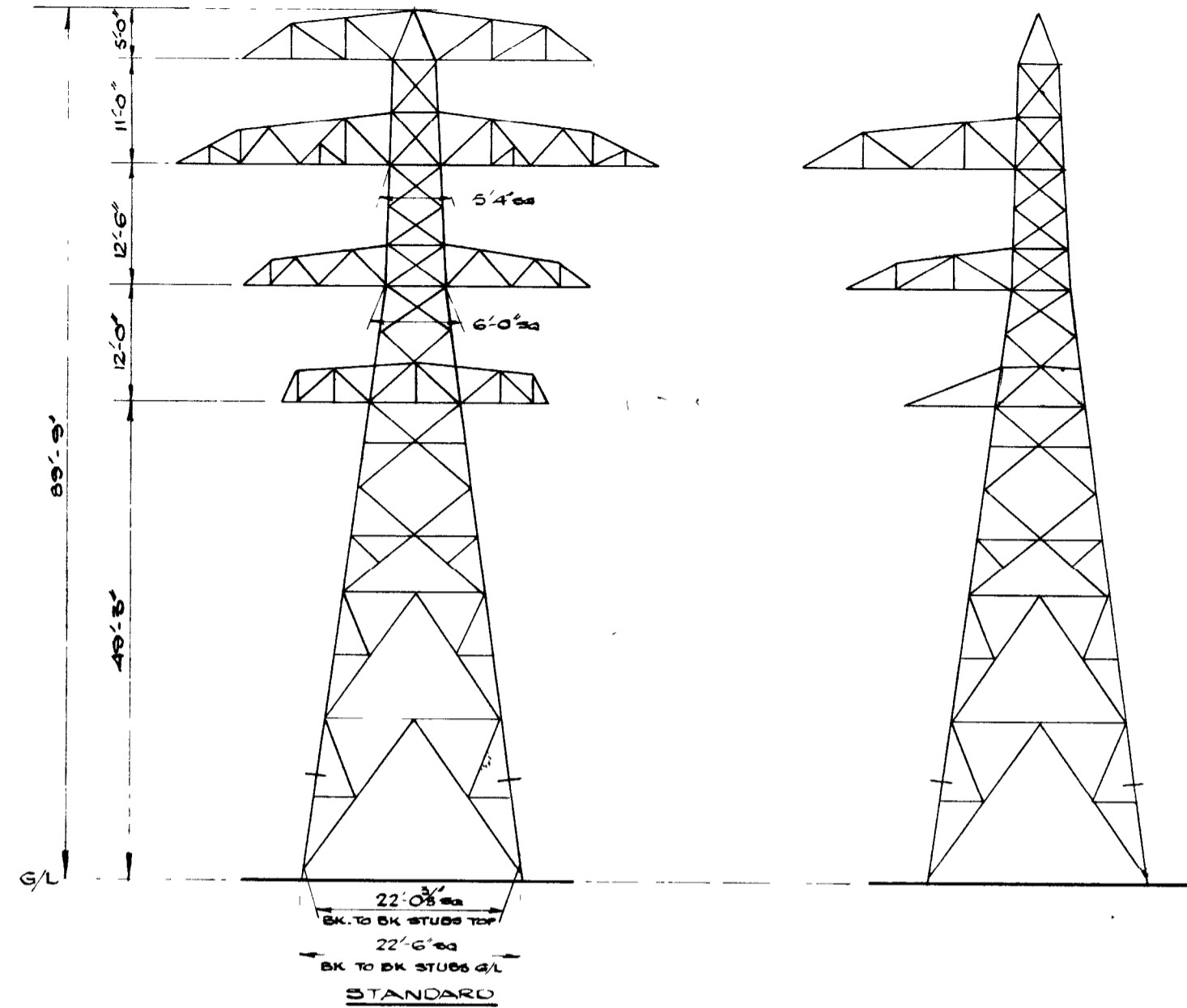

SP - STRAIN PLATES
* - DOWNLOAD POS'NS.

REF DRGS	GEN ARRET	ERECTION
STANDARD (TOP HALF)	35/876	35/930
" (BOTTOM HALF)	35/902	35/915
CROSSARMS.	35/875	35/931
PEAK	35/3145	
AUX CROSSARMS	35/3440 & 35/3441	
E 10	35/879	35/929
E 20	35/3600	35/3135
E 40		35/5787

DRAWN	L.W.F	7 12 92
TRACED		
CHECKED		

D.D.T. TOWER. (BLAW KNOX)
DESIGN TYPE: S.W.E. PL. 16.
SCALE: 1/2" TO 1 FT

DRG. NO. ED. 5115

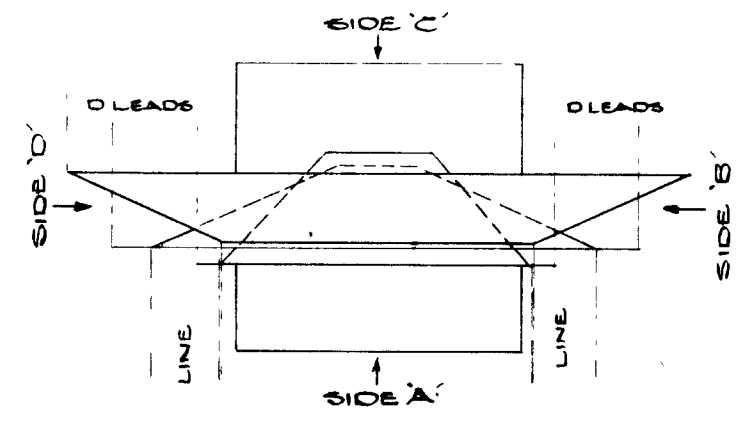
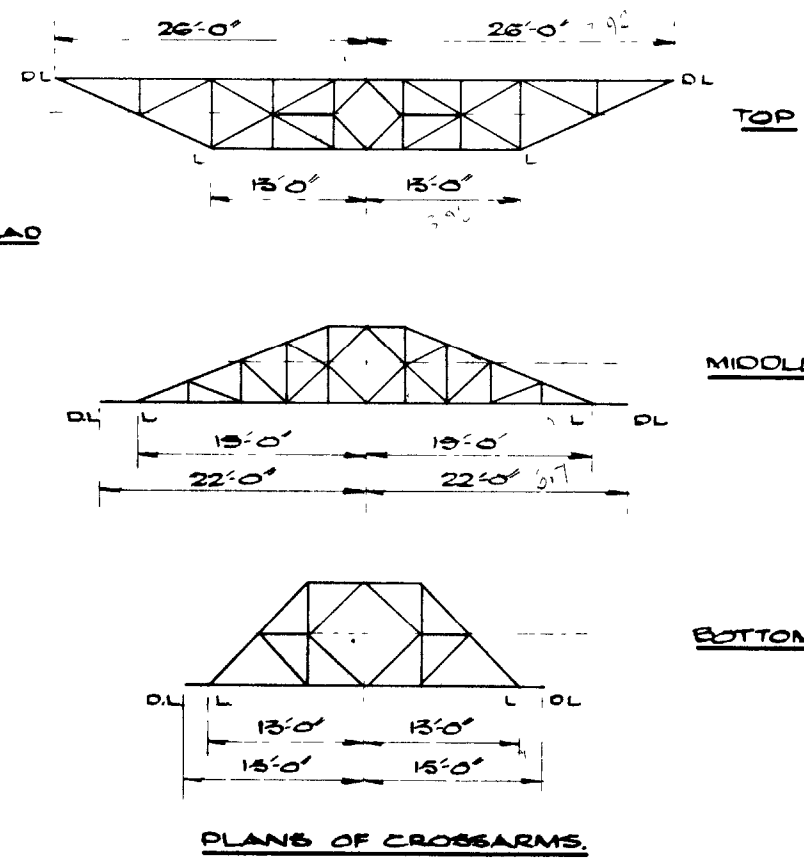
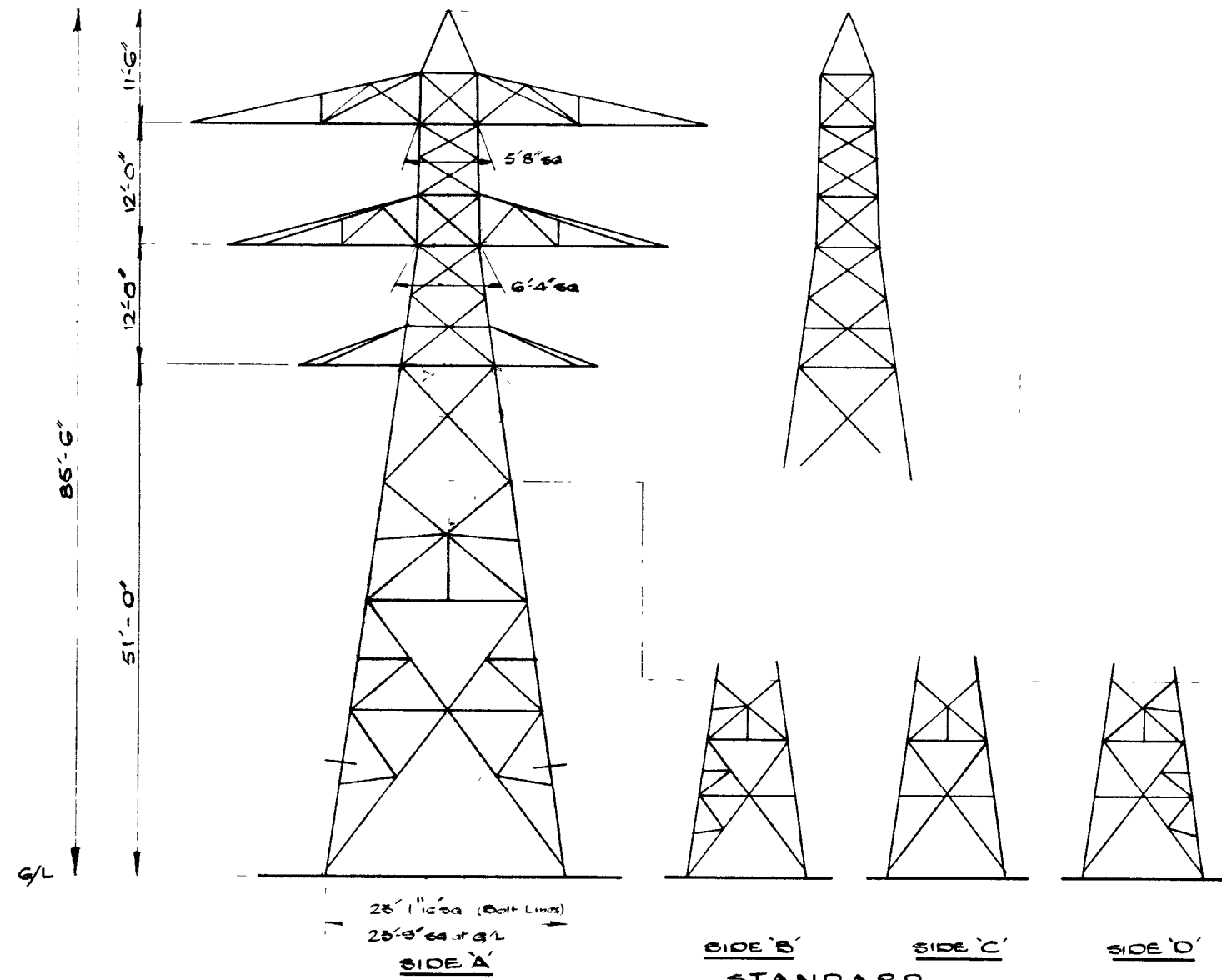

REF DRGS:

STANDARD	GEN ARRGT 35/3251
CROSSARMS	34/3252
E 10	
E 20	
E 30	
E 40	35/4163
LINE DIAGRAMS	34/3259

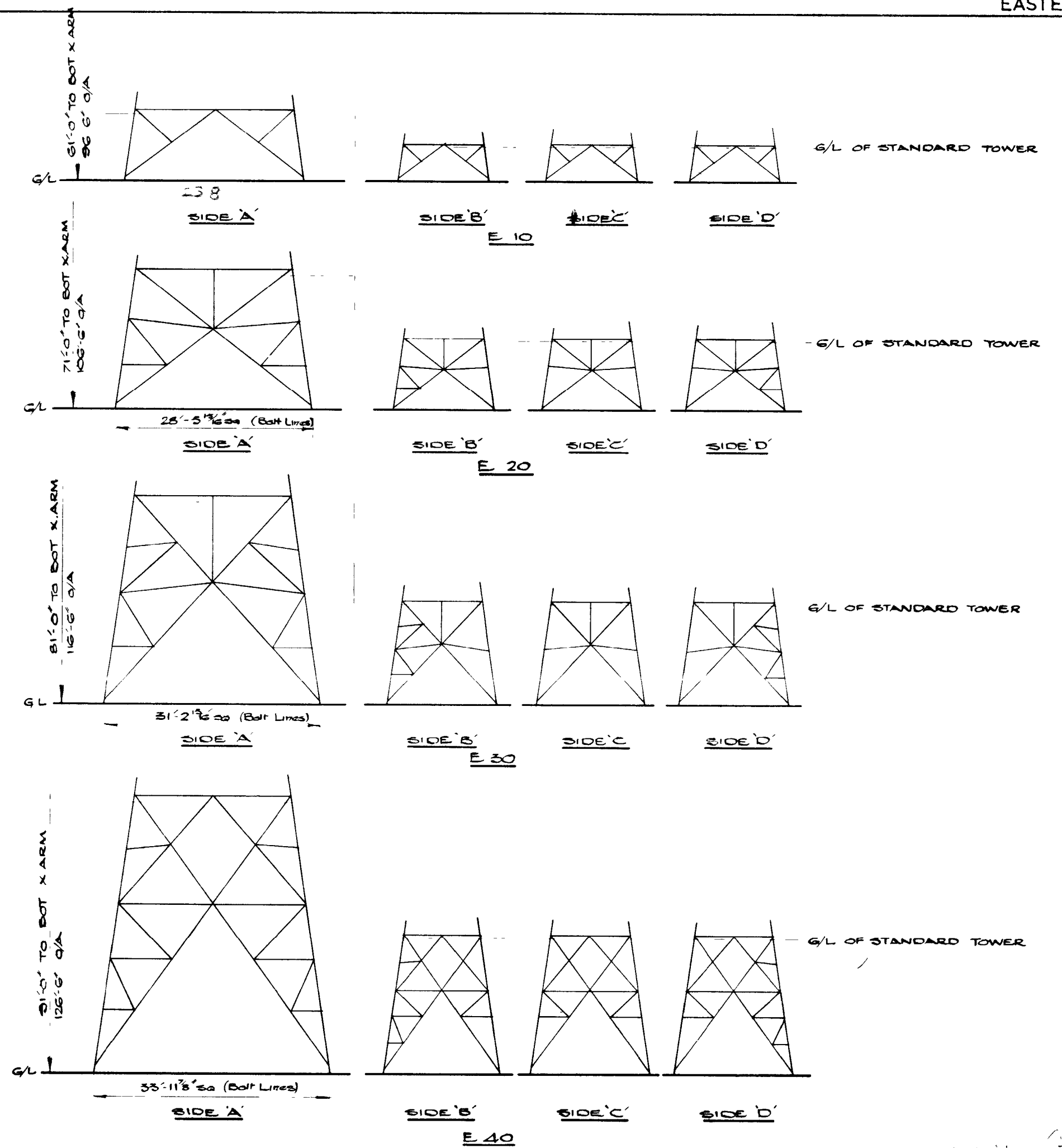

DRAWN	L.W.F. 10 12-46
TRACED	
CHECKED	

D.T. & D.T. 90° TOWER.
 DESIGN TYPE: J.L. EVE.
 SCALE: 1/8" & 1/32" TO 1 FT

DRG. NO. **ED. 51151.**